

# Best Practices for Emergency Response to Incidents Involving Electric Vehicles Battery Hazards: A Report on Full-Scale Testing Results

*Final Report*

Prepared by:

R. Thomas Long Jr., P.E., CFEI  
Andrew F. Blum, P.E., CFEI  
Thomas J. Bress, Ph.D., P.E., CRE  
Benjamin R.T. Cotts, Ph.D.

Exponent, Inc.  
17000 Science Drive, Suite 200  
Bowie, MD 20715

© June 2013 Fire Protection Research Foundation



THE  
FIRE PROTECTION  
RESEARCH FOUNDATION

## FIRE RESEARCH

THE FIRE PROTECTION RESEARCH FOUNDATION  
ONE BATTERYMARCH PARK  
QUINCY, MASSACHUSETTS, U.S.A. 02169-7471  
E-MAIL: [Foundation@NFPA.org](mailto:Foundation@NFPA.org)  
WEB: [www.nfpa.org/Foundation](http://www.nfpa.org/Foundation)

(This page left intentionally blank)

## FOREWORD

Fires involving cars, trucks and other highway vehicles are a common concern for emergency responders. Fire Service personnel are accustomed to responding to conventional vehicle fires, and generally receive training on the hazards associated with vehicle subsystems (e.g., air bag initiators, seat belt pre-tensioners, etc). For vehicle fires, and in particular fires involving electric drive vehicles, a key question for emergency responders is: “what is different with electric drive vehicles and what tactical adjustments are required?”

The overall goal of this project is to conduct a research program to develop the technical basis for best practices for emergency response procedures for electric drive vehicle battery incidents, with consideration for certain details including: suppression methods and agents; personal protective equipment (PPE); and clean-up/overhaul operations. A key component of this project goal is to conduct full-scale testing of large format Li-ion batteries used in these vehicles. This report summarizes these tests, and includes discussion on the key findings relating to best practices for emergency response procedures for electric drive vehicle battery incidents.

The Research Foundation expresses gratitude to the report authors R. Thomas Long Jr., Andrew F. Blum, Thomas J. Bress, and Benjamin R.T. Cotts, all with Exponent, Inc. (Bowie, Maryland). Appreciation is expressed to the Project Technical Panelists and all others who contributed to this research effort. Special thanks are expressed to the following project sponsors for providing the funding for this project: Department of Energy; Department of Transportation; and Alliance of Automobile Manufacturers. Gratitude is also extended to Battelle and Idaho National Laboratory, Southwest Research Institute, and Maryland Fire Rescue Institute for their on-going guidance and use of facilities.

The content, opinions and conclusions contained in this report are solely those of the authors.

(This page left intentionally blank)

## **PROJECT SPONSORS**

*Alliance of Automobile Manufacturers*



**AUTO ALLIANCE**  
**DRIVING INNOVATION®**

*U.S. Department of Energy (Idaho National Laboratory)*



*U.S. Department of Transportation (National Highway Traffic Safety Administration)*



## **PROJECT TECHNICAL PANEL**

David Anderson, DOE, Department of Energy  
David Bryson, NHTSA, National Highway Transportation and Safety Administration  
Chris Dubay, NFPA, National Fire Protection Association  
James Francfort, Idaho National Laboratory  
Andrew Klock, NFPA, National Fire Protection Association  
Steve Pegram, IAFC, International Association of Fire Chiefs  
Anthony Putorti, NIST, National Institute of Standards and Technology  
Scott Schmidt, Alliance of Automobile Manufacturers (Alliance)  
Robert Strassburger, Alliance of Automobile Manufacturers (Alliance)  
Ken Willette, NFPA, National Fire Protection Association

(This page left intentionally blank)

## **EMERGENCY RESPONDER ADVISORY PANEL**

Daniel Bates, New York State Police  
Maria Bianchi, AAA, American Ambulance Association  
Jim Carroll, NAFTD, CT Fire Academy  
Laura Cathcart, NAEMT, State of Maryland  
Frank Cheatham, NASEMSO, National Association of EMS Officials  
Gregg Cleveland, NFPA Fire Service Section, La Crosse Fire Dept, La Crosse WI  
Don Cooper, NFPA 1670 TC Chair, Ohio State Fire Marshal's Office  
John Cunningham, NAFTD, Nova Scotia Firefighter's School  
Karen Deppa, NASFM  
Rich Duffy, Alexandria VA  
Gregory Frederick, Metro Chiefs, Louisville Fire & Rescue., Louisville, KY  
Bill Giorgis, Michigan Towing Association, Mike's Wrecker Service, Saginaw, MI  
Victoria Lee, IAFC  
Stéphan Lepouriel, Major - Civil Security and Crisis Management, France  
Terry McDonnell, New York State Police, Albany, NY  
Ron McGraw, IAFF, Washington DC  
Larry McKenna, USFA, Emmitsburg MD  
Jim Narva, NASFM, National Association of State Fire Marshals  
Steve Pegram, IAFC & ISFSI, Goshen Township Fire & EMS, Goshen OH  
Al Rosamond, NVFC, Hixon TN  
Tony Sanfilippo, IFMA, Michigan Bureau of Fire Services

## **BATTERY TECHNOLOGY ADVISORY PANEL**

Domenico Gabrielli, Ford Motor Company  
Robert Galyen, Chair - SAE EV Battery Committee  
Mark Gielow, Mercedes Benz  
Oliver Gross, Chrysler Group  
Christopher Michelbacher, Idaho National Laboratory  
Ron Orlando, General Motors Corp  
Doug Sato, Toyota Motor Sales USA  
Mark Saxonberg, Toyota Motor Sales USA  
Keith Schultz, General Motors Corporation  
Dan Selke, Mercedes Benz  
Mathew Shirk, Idaho National Laboratory  
Simon Wilkinson, Chrysler Group  
Keith Wilson, SAE International  
Mark Yeldham, BMW of North America

(This page left intentionally blank)



Exponent<sup>®</sup>

*Thermal Sciences*

**Best Practices for Emergency  
Response to Incidents  
involving Electric Vehicle  
Battery Hazards: A Report on  
Full-scale Testing Results**



# **Best Practices for Emergency Response to Incidents involving Electric Vehicle Battery Hazards**

Prepared for

Fire Protection Research Foundation  
One Batterymarch Park  
Quincy, MA 02169

Prepared by

R. Thomas Long Jr., P.E., CFEI  
Andrew F. Blum, P.E., CFEI  
Thomas J. Bress, Ph.D., P.E., CRE  
Benjamin R.T. Cotts, Ph.D.  
Exponent, Inc.  
17000 Science Drive, Suite 200  
Bowie, MD 20715

June 27, 2013

© Exponent, Inc.

# Contents

---

	<u>Page</u>
<b>List of Figures</b>	<b>vi</b>
<b>List of Tables</b>	<b>xi</b>
<b>Acronyms and Abbreviations</b>	<b>xiii</b>
<b>Limitations</b>	<b>xv</b>
<b>Executive Summary</b>	<b>xvi</b>
<b>1 Background</b>	<b>1</b>
1.1 Project History	1
1.2 Research Objectives and Project Scope	2
1.2.1 Review of Industry Best Practices for Firefighting	3
1.2.2 Identification, Categorization, and Prioritization of Battery Technologies and Representative Battery Types	3
1.2.3 Identification of Key Required Elements of PPE, Tactics, and Overhaul Operations	3
1.2.4 Development of Full-Scale Fire Testing Program	4
1.2.5 Full-scale Fire Testing	4
1.2.6 Report and Summary of Best Practices	4
<b>2 Current State of Emergency Response to ICE and EDV Fires</b>	<b>6</b>
2.1 Li-ion Overview	6
2.2 Electric Vehicle Overview	12
2.3 Current EDV Research and Other Efforts	13
2.4 Overview of Vehicle Fires	15
2.5 Conventional ICE Vehicle Fires	17
2.6 Current Conventional ICE Vehicle Fire Tactics	18
2.7 Current EDV Fire Tactics	20
2.7.1 Identify the Vehicle	21
2.7.2 Immobilize the Vehicle	21
2.7.3 Disable the Vehicle	22
2.7.4 Extrication	24

2.7.5	Extinguishment	24
2.7.6	Overhaul Operations	25
2.8	High Voltage Battery Fires	26
2.9	Summary	28
<b>3</b>	<b>Testing Program Summary</b>	<b>30</b>
<b>4</b>	<b>Battery Descriptions</b>	<b>32</b>
4.1.1	Battery A	32
4.1.2	Battery B	34
<b>5</b>	<b>Test Setup</b>	<b>36</b>
5.1	HRR Testing	36
5.1.1	Battery Positioning	38
5.1.2	Burner Description	39
5.1.3	HRR Measurements	45
5.1.4	Products of Combustion Gas Sampling	45
5.1.5	Temperature and Heat Flux Measurements	46
5.1.6	Internal Battery Sensor Measurements	49
5.1.7	DAQ System	52
5.1.8	Thermal Imaging, Still Photography and High Definition Video	53
5.2	Full-scale Fire Suppression Testing	53
5.2.1	VFT and Battery Positioning	55
5.2.2	Burner Description	68
5.2.3	Electrical Measurements during Fire Suppression	68
5.2.4	Water Sampling	73
5.2.5	Temperature and Heat Flux Measurements	74
5.2.6	Internal Battery Sensor Measurements	78
5.2.7	DAQ System	81
5.2.8	Thermal Imaging, Still Photography and High Definition Video	82
5.2.9	Suppression Activities	83
5.3	Full-scale Fire Protocols	85
5.3.1	HRR Testing	85
5.3.2	Suppression Testing	86
<b>6</b>	<b>Test Results</b>	<b>89</b>
6.1	HRR Testing	89
6.1.1	Battery B	89

6.2	Suppression Testing	101
6.2.1	Battery A1 Test	101
6.2.2	Battery A2 Test	112
6.2.3	Battery A3 Test	123
6.2.4	Battery B1 Test	139
6.2.5	Battery B2 Test	153
6.2.6	Battery B3 Test	168
<b>7</b>	<b>Discussion</b>	<b>185</b>
7.1	Overall Test Observations	185
7.2	Firefighting Tactics	186
7.3	First Responder PPE	187
7.4	Electrical Hazards	187
7.5	Respiratory Hazards	188
7.6	Water Hazards	188
7.7	Extinguishing Agent (Water)	189
7.8	Water Flow Calculations	189
7.9	Overhaul and Cleanup	190
<b>8</b>	<b>Key Findings</b>	<b>191</b>
8.1	Emergency Responder Questions and Answers	191
8.2	Suggested Best Practices for Tactics and PPE	194
8.2.1	General Procedures for Hybrid and EDV Fire Suppression	194
8.2.2	Personal Protective Equipment	195
8.2.3	Extinguishing Agents	195
8.2.4	Tactics	198
8.2.5	Fires Involving Charging Stations	199
8.2.6	Overhaul and Recovery	199
<b>9</b>	<b>Recommendations and Future Work</b>	<b>201</b>
<b>10</b>	<b>Acknowledgements</b>	<b>202</b>
<b>Appendix A</b>	<b>SwRI Test Report</b>	<b>203</b>
<b>Appendix B</b>	<b>VFT Design Drawings</b>	<b>204</b>
<b>Appendix C</b>	<b>Microbac Laboratories Report</b>	<b>205</b>

<b>Appendix D</b>	<b>Analyze, Inc. Report</b>	<b>206</b>
<b>Appendix E</b>	<b>Electrical Measurements</b>	<b>207</b>

# List of Figures

---

	<u>Page</u>
Figure 1 Li-ion cell operation, during charging lithium ions intercalate into the anode, the reverse occurs during discharge	8
Figure 2 Base of a cylindrical Li-ion cell showing wound structure (top); Cell being unwound revealing multiple layers: separator is white, aluminum current collector (part of cathode) appears shiny (bottom)	9
Figure 3 Example of 18650 cylindrical cells (these are the most common consumer electronics Li-ion cell form factor)	10
Figure 4 Example of a hard case prismatic cell	10
Figure 5 Example of a soft-pouch polymer cell	11
Figure 6 Battery A	33
Figure 7 Battery A cargo area over the battery compartment	33
Figure 8 Battery A compartment in cargo area with carpet and molded plastic cover removed	34
Figure 9 Battery B	35
Figure 10 Battery B installed in vehicle	35
Figure 11 Battery B configuration and burner locations for HRR testing	38
Figure 12 Layout and arrangement of the HRR testing perimeter instrumentation	39
Figure 13 Layout of burner assembly	42
Figure 14 Burner assembly (top); single burner (bottom left); and DAQ (bottom right)	43
Figure 15 T-shaped burner arrangement comprised of four burners	44
Figure 16 Four burners positioned under Battery B	44
Figure 17 SwRI hood and test arrangement	46
Figure 18 TC locations around Battery B during HRR testing (see Figure 12 for TC and HFG positions around the perimeter of the battery pack)	48
Figure 19 Installation of typical TCs inside Battery B	49
Figure 20 NI 9862 CAN bus module and 7-port NI CAN breakout box	51
Figure 21 Location of the connection points to the internal battery sensors (circled right)	51

Figure 22 Protection scheme for the connection points and cables	52
Figure 23 VFT design drawing	56
Figure 24 VFT: Side profile (top); rear profile with hatchback open (bottom left); and front profile with hood open (bottom right)	57
Figure 25 Carriage installed inside the VFT positioned above the four burners located in the rear test position	58
Figure 26 Battery A positioned on the carriage above the burners and inside the VFT	58
Figure 27 Battery B positioned on the carriage above the burners inside the VFT; burners located in the center test position	59
Figure 28 Layout and arrangement of the suppression testing perimeter instrumentation	60
Figure 29 Overall view of the VFT with interior finishes for Test A3	60
Figure 30 Dashboard and front seats installed inside the VFT for Test A3	61
Figure 31 Front seats installed inside the VFT for Test A3	61
Figure 32 Back seats installed inside the VFT for Test A3	62
Figure 33 Carpet installed on top of the battery for Test A3	62
Figure 34 View of Battery B inside the VFT without the floor pan (top) and with the floor pan (bottom); the blue tank at the rear of the battery is the empty gasoline tank for the production vehicle, which blocks direct access to the rear of the battery	64
Figure 35 Top view of Battery B inside the VFT without the floor pan (top) and with the floor pan (bottom); the yellow fuse in the middle of the red floor pan is the only hole within the pan that allows for access to the battery	65
Figure 36 Overall view of the VFT with interior finishes for Test B3	66
Figure 37 Dashboard, front seats, and carpet installed inside the VFT for Test B3	66
Figure 38 Front seats and carpet installed inside the VFT for Test B3	67
Figure 39 Back seats installed inside the VFT for Test B3	67
Figure 40 Back seats and carpet installed inside the VFT for Test B3	68
Figure 41 14 AWG stranded copper wire soldered to a hose clamp and affixed to the nozzle's exterior housing	71
Figure 42 Simplified circuit diagram for the electrical measurements	72
Figure 43 Water sample collection during test A1 just in front of the VFT	74
Figure 44 TC locations (red circles) on battery exterior for Battery A tests	76



Figure 45 TC locations (red circles) on battery exterior/interior for Battery B tests	77
Figure 46 Connection points to Battery B once installed inside the VFT (before protection)	79
Figure 47 Protection scheme for the connection points and cables running to Battery B	80
Figure 48 NI 9213 TC module and NI 9207 voltage module (for HFGs) plugged into the NI cDAQ 9178 data acquisition chassis	82
Figure 49 VFT windows were all open to air and the top portion of the back hatch was kept open to during the tests	85
Figure 50 0 minutes (top left), 2:30 minutes (top right), 4:20 minutes (bottom left), 13 minutes (bottom right)	91
Figure 51 14:50 minutes: A large stream of sparks shoot out from the bottom of the NW end of the battery from its interior	92
Figure 52 20:40 minutes (top left), 25:00 minutes (top right), 47:10 minutes (bottom left), 01:34:00 minutes (bottom right)	93
Figure 53 HRR as a function of time	95
Figure 54 Internal cell voltages and temperatures (Sensor #7) during HRR Testing	98
Figure 55 Location of Temperature Sensor #7 within Battery B	99
Figure 56 Thermal image 0 hours (top); 2 hours (middle); and 3 hours (bottom) after visible flaming ceased	100
Figure 57 Test A1: ignition (top left); off gassing (top right); fully involved (bottom left); burners off (bottom right)	104
Figure 58 Test A1: Suppression starts (top left); reignition and suppression (top right, bottom left); post suppression (bottom right)	105
Figure 59 Test A1 TC plot	108
Figure 60 Test A1 HFG plot	109
Figure 61 Battery A1 from rear of VFT (top); thermal image (same view) of Battery A1 at 25 minutes (bottom)	111
Figure 62 Test A2: ignition (top left); off gassing (top right); fully involved (bottom left); burners off (bottom right)	115
Figure 63 Test A2: suppression starts (top left); reignition and suppression (top right, bottom left); post-suppression (bottom right)	116
Figure 64 Test A2 TC plot	119
Figure 65 Test A2 HFG plot	120

Figure 66 Battery A2 from rear of VFT (top); thermal image (same view) of Battery A2 at 40 minutes depicting the “hot spot” (bottom)	122
Figure 67 Test A3: ignition (top left); rear involved (top right); fully involved (bottom left); burners off (bottom right)	127
Figure 68 Test A3: Suppression starts (top left); reignition and suppression (top right, bottom left); post suppression (bottom right)	128
Figure 69 Test A3 TC plot	132
Figure 70 Test A3 HFG plot	132
Figure 71 Battery A3 from rear of VFT (top); thermal image (same view) of Battery A3 at 41 minutes depicting the “hot spot” (bottom)	135
Figure 72 Off gassing of Battery A3 approximately 22 hours after the conclusion of the test	136
Figure 73 Reignition of Battery A3 approximately 22 hours after the conclusion of the test (flame circled red)	137
Figure 74 Test B1: ignition (top left); off gassing (top right); fully involved (bottom left); burners off (bottom right)	142
Figure 75 Test B1: suppression starts (top left); reignition and suppression (top right, bottom left); post suppression (bottom right)	143
Figure 76 Test B1 TC plot	148
Figure 77 Test B1 HFG plot	148
Figure 78 Floor pan assembly from rear of VFT (top); thermal image (same view) of Battery B1 at 60 minutes (bottom)	151
Figure 79 Extended temperature measurements for Test B1	152
Figure 80 Test B2: ignition (top left); off gassing (top right); flames from fuse (bottom left); burners off (bottom right)	156
Figure 81 Test B2: suppression starts (top left); reignition and suppression (top right, bottom left); post suppression (bottom right)	157
Figure 82 Test B2 TC plot	162
Figure 83 Test B2 HFG plot	162
Figure 84 Internal cell voltages and temperatures during Test B2	163
Figure 85 Location of temperature Sensor #6 within Battery B2	164
Figure 86 Floor pan assembly from rear of VFT (top); thermal image (same view) of Battery B2 at 75 minutes (bottom)	166

Figure 87 Extended temperature measurements for Test B2	168
Figure 88 Test B3: ignition (top left); off gassing (top right); fully involved (bottom left); burners off (bottom right)	172
Figure 89 Test B3: suppression starts (top left); reignition and suppression (top right, bottom left); post suppression (bottom right)	173
Figure 90 Test B3 TC plot	177
Figure 91 Test B3 HFG plot	177
Figure 92 Internal cell voltages and temperatures during Test B3	178
Figure 93 Floor pan assembly from side of VFT (top); thermal image (same view) of Battery B3 at 60 minutes (bottom)	181
Figure 94 Extended temperature measurements for Test B3	183

## List of Tables

---

	<u>Page</u>
Table 1 Burner Assembly Components	40
Table 2 Summary of TC Locations	47
Table 3 Summary of HFG Locations	47
Table 4 Summary of TC Locations	75
Table 5 Summary of HFG Locations	75
Table 6 Summary of Key Observations from the HRR Test	90
Table 7 Summary of HRR Measurements	95
Table 8 Summary of Maximum Temperature Measurements	96
Table 9 Summary of Maximum Heat Flux Measurements	97
Table 10 Test A1 Key Observations	102
Table 11 Test A1 Water Flow Times	106
Table 12 Summary of Test A1 Maximum Temperature Measurements	107
Table 13 Summary of Test A1 Maximum Heat Flux Measurements	108
Table 14 Summary of Test A1 Current (mA) and Voltage (V) Measurements	109
Table 15 Summary of Test A1 Temperature Measurements after 60 Minutes	112
Table 16 Test A2 Key Observations	113
Table 17 Test A2 Water Flow Times	117
Table 18 Summary of Test A2 Maximum Temperature Measurements	119
Table 19 Summary of Test A2 Maximum Heat Flux Measurements	119
Table 20 Summary of Test A2 Current (mA) and Voltage (V) Measurements	120
Table 21 Summary of Test A2 Temperature Measurements after 60 Minutes	123
Table 22 Test A3 Key Observations	124
Table 23 Test A3 Water Flow Times	129
Table 24 Summary of Test A3 Maximum Temperature Measurements	131
Table 25 Summary of Test A3 Maximum Heat Flux Measurements	131

Table 26 Summary of Test A3 Current (mA) and Voltage (V) Measurements	133
Table 27 Summary of Test A3 Temperature Measurements after 60 Minutes	136
Table 28 Water Sample Analysis Summary for Test A3	138
Table 29 Test B1 Key Observations	140
Table 30 Test B1 Water Flow Times	144
Table 31 Summary of Test B1 Maximum Temperature Measurements	147
Table 32 Summary of Test B1 Maximum Heat Flux Measurements	147
Table 33 Summary of Test B1 Current (mA) and Voltage (V) Measurements	149
Table 34 Summary of Test B1 Temperature Measurements after 1, 2, 3, 6, 12, and 18 hours	152
Table 35 Test B2 Key Observations	154
Table 36 Test B2 Water Flow Times	158
Table 37 Summary of Test B2 Maximum Temperature Measurements	161
Table 38 Summary of Test B2 Maximum Heat Flux Measurements	161
Table 39 Summary of Test B2 Current (mA) and Voltage (V) Measurements	164
Table 40 Summary of Test B2 Temperature Measurements after 1, 2, 3, 6, 12, and 18 hours	167
Table 41 Test B3 Key Observations	169
Table 42 Test B3 Water Flow Times	174
Table 43 Summary of Test B3 Maximum Temperature Measurements	176
Table 44 Summary of Test B3 Maximum Heat Flux Measurements	176
Table 45 Summary of Test B3 Current (mA) and Voltage (V) Measurements	179
Table 46 Summary of Test B3 Temperature Measurements after 1, 2, 3, 6, 12, and 18 hours	182
Table 47 Water Sample Analysis Summary for Test B3	184
Table 48 Summary of Water Flow Calculations for all Tests	190

## Acronyms and Abbreviations

---

AC	alternating current
Ah	Ampere hour
BEV	battery electric vehicle
CAN	controller area network
DC	direct current
DOE	Department of Energy
DOT	Department of Transportation
EDV	electric drive vehicle
EREV	extended range electric vehicle
EV	electric vehicle
FMVSS	Federal Motor Vehicle Safety Standard
FPRF	Fire Protection Research Foundation
FTIR	Fourier transform infrared
gpm	gallons per minute
HCl	hydrogen chloride
HCN	hydrogen cyanide
HEV	hybrid electric vehicle
HF	hydrogen fluoride
HRR	heat release rate
HV	hybrid vehicle
Hz	Hertz
ICE	internal combustion engine
IFSTA	International Fire Service Training Association
kHz	kilohertz
kW	kilowatt
kWh	kilowatt hour
m	meter
MFRI	Maryland Fire and Rescue Institute
MJ	mega joule
mph	miles per hour
ms	millisecond
MW	megawatt
NiMH	Nickel metal hydride
NFPA	National Fire Protection Association
NHTSA	National Highway Traffic Safety Administration
NO <sub>x</sub>	nitrogen oxides
OEL	occupational exposure limits

PBI	Polybenzimidazole
PBZ	personal breathing zone
PPE	personal protective equipment
PHEV	plug-in hybrid electric vehicle
RESS	Rechargeable Energy Storage System
SAE	Society of Automotive Engineers
SCBA	self-contained-breathing-apparatus
S	Siemens
SOC	state of charge
SRS	supplemental restraint system
SwRI	Southwest Research Institute
UL	Underwriters Laboratories
V	volt
VDC	volts direct current
VFT	vehicle fire trainer
VOC	volatile organic compound
Wh	Watt hour

## Limitations

---

At the request of the Fire Protection Research Foundation (FPRF), Exponent assessed the best practices for emergency response to electric drive vehicle (EDV) battery hazards. This report summarizes a full-scale fire testing and suppression program involving full size hybrid electric (HEV) and extended range electric vehicle (EREV) lithium ion (Li-ion) batteries installed in a vehicle fire trainer (VFT) prop. The scope of services performed during this testing program may not adequately address the needs of other users of this report, and any re-use of this report or its findings, conclusions, or recommendations presented herein are at the sole risk of the user.

The full-scale vehicle mockup test strategy, burner exposure protocol, and any recommendations made are strictly limited to the test conditions included and detailed in this report. The combined effects (including, but not limited to) of different battery types, vehicle types, collision damage, battery energy density and design, state of charge, cell chemistry, etc. are yet to be fully understood and may not be inferred from these test results alone.

The findings formulated in this review are based on observations and information available at the time of writing. The findings presented herein are made to a reasonable degree of scientific and engineering certainty. If new data becomes available or there are perceived omissions or misstatements in this report, we ask that they be brought to our attention as soon as possible so that we have the opportunity to fully address them.



# Executive Summary

---

This report summarizes full-scale heat release rate (HRR) and fire suppression testing of EDV large format Li-ion batteries.

In an effort to bolster preliminary guidance issued by the National Fire Protection Association (NFPA) for fire emergencies involving EDVs, full-scale fire suppression tests were conducted to collect data and evaluate any differences associated with EDV fires as compared to traditional internal combustion engine (ICE) vehicle fires. EDVs may pose new, unknown risks and variables to emergency responders. In particular, members of the emergency response community have questions regarding, (1) personal protective equipment (PPE); (2) firefighting suppression tactics; and (3) the best practices for overhaul and post-fire clean-up. Specifically, questions from the emergency response community regarding these three topics include:

1. Appropriate PPE to be used for responding to fires involving EDV batteries:
  - a. Is current PPE appropriate with regard to respiratory and dermal exposure to vent gases and combustion products?
  - b. Is current PPE appropriate with regard to potential electric shock hazards?
  - c. What is the size of the hazard zone where full PPE, including respiratory protection, must be worn?
2. Tactics for suppression of fires involving EDV batteries:
  - a. How effective is water as a suppressant for large battery fires?
  - b. Are there projectile hazards?
  - c. How long must suppression efforts be conducted to place the fire under control and then fully extinguish it?
  - d. What level of resources will be needed to support these fire suppression efforts?
  - e. Is there a need for extended suppression efforts?

- f. What are the indicators for instances where the fire service should allow a large battery pack to burn rather than attempt suppression?
3. Best practices for tactics and PPE to be used during overhaul and post-fire clean-up operations.

The scope of work included, but was not limited to, the following six primary tasks:

1. A review of industry best practices for firefighting tactics for ICE and EDVs (see Section 2);
2. Identification, categorization, and prioritization of battery technologies and representative battery types for full-scale testing in conjunction with the Project Technical Panel and their advisory groups (see Section 4);
3. Identification of the key required elements of EDV emergency response PPE, tactics, and overhaul operations (see Section 2);
4. Development of full-scale fire testing program for each battery to be tested (see Section 5);
5. Full-scale fire testing per the full-scale fire testing program developed above, including one un-suppressed HRR test and six suppressed tests (see Section 6); and
6. Report of final results and summary of the best practices for emergency response to incidents involving EDV battery hazards.

In summary, this project involved full-scale HRR and fire suppression testing of EDV batteries alone (HRR test) and installed within a generic VFT prop (fire suppression tests). Fire suppression tests were conducted with and without vehicle interior finishes. All tests subjected the batteries to simulated exposure fires originating underneath the vehicle chassis. All fire suppression activities were conducted by qualified active duty firefighters.

The overriding goal of this research project was to collect data to bolster current guidance provided by NFPA through their *Electric Vehicle Emergency Field Guide*. A full listing of project observations as they relate to the current NFPA guidance is provided in Section 8 of this report.

# 1 Background

---

## 1.1 Project History

In 2009, the National Fire Protection Association (NFPA) began a partnership with the U.S. Department of Energy (DOE) and the automotive industry to develop and implement a comprehensive training program to provide safety training to emergency responders to prepare them for their role in safely handling incidents involving electric drive vehicles (EDVs). Throughout this report, the term EDV is used to describe a passenger road vehicle with an electric drive power system capable of propelling the vehicle solely by electric power or in combination with the internal combustion engine (ICE). This program had a lack of data to draw on to address the potential hazards associated with damaged EDV batteries. EDVs may pose new, unknown risks and variables to emergency responders. In particular, members of the emergency response community have questions regarding, (1) personal protective equipment (PPE); (2) firefighting suppression tactics; and (3) the best practices for overhaul and post-fire clean-up. Specifically, questions from the emergency response community include:

1. Appropriate PPE to be used for responding to fires involving EDV batteries:
  - a. Is current PPE appropriate with regard to respiratory and dermal exposure to vent gases and combustion products?
  - b. Is current PPE appropriate with regard to potential electric shock hazards?
  - c. What is the size of the hazard zone where full PPE, including respiratory protection, must be worn?
2. Tactics for suppression of fires involving EDV batteries:
  - a. How effective is water as a suppressant for large battery fires?
  - b. Are there projectile hazards?
  - c. How long must suppression efforts be conducted to place the fire under control and then fully extinguish it?
  - d. What level of resources will be needed to support these fire suppression efforts?

- e. Is there a need for extended suppression efforts?
  - f. What are the indicators for instances where the fire service should allow a large battery pack to burn rather than attempt suppression?
3. Best practices for tactics and PPE to be used during overhaul and post-fire clean-up operations.

## **1.2 Research Objectives and Project Scope**

The overall project research objective was to develop a technical basis for the best practices for emergency response for EDV battery incident firefighting, including the necessary PPE for first fire responders, the adequacy of water as a suppression agent, and the best practices for overhaul.

The scope of work included, but was not limited to, the following six primary tasks:

1. A review of industry best practices for firefighting tactics for ICE and EDVs (see Section 2);
2. Identification, categorization, and prioritization of battery technologies and representative battery types for full-scale testing in conjunction with the Project Technical Panel and their advisory groups (see Section 4);
3. Identification of the key required elements of EDV emergency response PPE, tactics, and overhaul operations (see Section 2);
4. Development of a full-scale fire testing program for each battery to be tested (see Section 5);
5. Full-scale fire testing per the full-scale fire testing program developed above, including one un-suppressed combustion test and six suppressed tests (see Section 6); and
6. Report of final results and summary of the best practices for emergency response to incidents involving EDV battery hazards.

A more detailed description of the tasks Exponent performed to fulfill the project objectives is provided below.

### **1.2.1 Review of Industry Best Practices for Firefighting**

Exponent collected, reviewed, and summarized available industry best practices for EDV battery incident firefighting as they relate to hazards, frequency, PPE, suppression tactics, suppression agents, overhaul, and clean-up. This task included a review of firefighting tactics literature, as well as technical discussions with the Maryland Fire and Rescue Institute (MFRI) in regards to industry best practices for fighting ICE and EDV fires (see Section 2).

### **1.2.2 Identification, Categorization, and Prioritization of Battery Technologies and Representative Battery Types**

Exponent, in conjunction with the Project Technical Panel, identified three candidate Li-ion batteries from three different EDV manufacturers for testing. Exponent assisted in analyzing and procuring the candidate batteries. A description of each battery is provided in Section 4.

Li-ion battery technology with an approximate capacity of 5.0 DC kWh or larger if designed for a plug-in hybrid electric vehicle (PHEV) or extended range electric vehicle (EREV) and 15.0 DC kWh or larger if designed for a battery electric vehicle (BEV) was used as a benchmark for the battery selection.

Exponent also worked with battery and automotive manufacturers to develop protocols for safe charging and characterization of the batteries prior to testing and safe discharge and removal of the batteries after testing, where required.

### **1.2.3 Identification of Key Required Elements of PPE, Tactics, and Overhaul Operations**

Exponent, in conjunction with the Project Technical Panel and MFRI, identified and summarized the key required elements of emergency response PPE, tactics, and overhaul operations based on a review of EDV fire hazards and traditional responses to vehicle and electrical fires involving energized equipment. This analysis included a review of industry references, as well as discussions with MFRI and automotive resources regarding PPE (see Section 2).

## **1.2.4 Development of Full-Scale Fire Testing Program**

Exponent, in conjunction with the Project Technical Panel and their advisory groups, developed an appropriate program for full-scale fire testing, separated into two categories: (1) HRR testing of a standalone battery pack and (2) full-scale fire suppression testing of battery packs in their correct mounting location positioned inside a vehicle fire trainer prop (VFT), along with other appropriate combustible materials, including vehicle interior finishes and components. The full-scale suppression tests involved a modified VFT prop to simulate typical vehicle fuel loads and ignition and containment of the Li-ion batteries.

## **1.2.5 Full-scale Fire Testing**

The full-scale fire testing involved one standalone HRR free-burn, unsuppressed fire test and suppressed fire tests of Li-ion batteries within a VFT. Instrumentation was provided to monitor fire growth and development, including, but not limited to, heat release rate, temperature, and heat flux. Gas samples and fire suppression water samples were collected for analysis of potential contaminants.

For testing that utilized the VFT, Exponent collaborated with MFRI, who provided expertise in incident command, firefighting tactics, overhaul operations, and firefighter PPE. Their training staff was utilized to identify recommended best practices for emergency response to EDV fire incidents and to facilitate the tests and suppression of the fires.

Active firefighters from MFRI performed all suppression and overhaul operations. Any hazardous events, such as projectile releases, adverse reactions to suppression agents, and electric shock were recorded.

## **1.2.6 Report and Summary of Best Practices**

Exponent collected and processed the test data from the full-scale testing program in this formal research engineering report. This report provides:

1. An overview of the project work to date;
2. A summary of the full-scale test data;

3. Comparison with comments from NFPA interim guidance; and
4. Identification of future potential research.

## 2 Current State of Emergency Response to ICE and EDV Fires

---

### 2.1 Li-ion Overview

Li-ion battery cells are in wide consumer use today. As this technology has evolved and the energy densities have increased, the use of this technology has been applied across many consumer products, including the automotive industry. Li-ion battery cells arranged in large format Li-ion battery packs are being used to power several types of EDVs. As EDVs enter the U.S. marketplace, there is an expectation of a steep increase in the number and size of battery packs in storage and use. A recent study by NFPA's FPRF<sup>1,2</sup> highlights the potential hazards and uses of Li-ion battery cells and packs during the life cycle of storage and distribution. An overview of the Li-ion technology and its failure modes is also included. A brief summary of Li-ion technology is provided here.

Li-ion has become the dominant rechargeable battery chemistry for consumer electronic devices and is poised to become commonplace for industrial, transportation, and power-storage applications. This chemistry is different from previously popular rechargeable battery chemistries (e.g., nickel metal hydride, nickel cadmium, and lead acid) in a number of ways. From a technological standpoint, because of high energy density, Li-ion technology has enabled the powering of EDVs. From a safety and fire protection standpoint, a high energy density coupled with a flammable organic, rather than aqueous, electrolyte has created a number of new challenges with regard to the design of batteries containing Li-ion cells, and with regard to fire suppression.

The term Li-ion refers to an entire family of battery chemistries. It is beyond the scope of this report to describe all of the chemistries used in commercial Li-ion batteries. In addition, it should be noted that Li-ion battery chemistry is an active area of research and new materials are constantly being developed. Additional detailed information with regard to Li-ion batteries is

---

<sup>1</sup> Long RT et al. "Lithium-Ion Batteries Hazard and Use Assessment." Fire Protection Research Foundation Report, July 2011. <http://www.nfpa.org/assets/files/PDF/Research/RFLithiumIonBatteriesHazard.pdf>

<sup>2</sup> Long RT, et al. "Lithium-ion batteries hazards: What you need to know." Fire Protection Engineering Q4 2012.



available in a number of references<sup>3,4</sup> and a large volume of research publications and conference proceedings on the subject.

In the most basic sense, the term Li-ion battery refers to a battery where the negative electrode (anode) and positive electrode (cathode) materials serve as a host for the lithium ion (Li<sup>+</sup>). Lithium ions move from the anode to the cathode during discharge and are intercalated (inserted into voids) in the crystallographic structure of the cathode. The ions reverse direction during charging, as shown in Figure 1. Since lithium ions are intercalated into host materials during charge or discharge, there is no free lithium metal within a Li-ion cell<sup>5,6</sup>, thus, if a cell ignites due to external flame impingement or an internal fault, metal fire suppression techniques are not appropriate for controlling the fire.

---

<sup>3</sup> *Linden's Handbook of Batteries*, 4<sup>th</sup> Edition, Thomas B. Reddy (ed), McGraw Hill, NY, 2011.

<sup>4</sup> *Advances in Lithium-Ion Batteries*, WA van Schalkwijk and B Scrosati (eds), Kluwer Academic/Plenum Publishers, NY, 2002.

<sup>5</sup> Under certain abuse conditions, lithium metal in very small quantities can plate onto anode surfaces. However, this should not have any appreciable effect on the fire behavior of the cell.

<sup>6</sup> There has been some discussion about the possibility of "thermite-style" reactions occurring within cells (reaction of a metal oxide with aluminum, for example iron oxide with aluminum, the classic thermite reaction, or in the case of lithium-ion cells cobalt oxide with aluminum current collector). Even if thermodynamically favored (based on the heats of formation of the oxides), generally these types of reactions require intimate mixtures of fine powders of both species to occur. Thus, the potential for aluminum current collector to undergo a thermite-style reaction with a cathode material may be possible, but aluminum in bulk is difficult to ignite (Babrauskas V, *Ignition Handbook*, Society of Fire Protection Engineers, 2003, p. 870) and thus, the reaction may be kinetically hindered. Ignition temperatures of thermite style reactions are heavily dependent upon surface properties. Propagation of such reactions can also be heavily dependent upon mixture properties. To date, Exponent has not observed direct evidence of thermite style reactions within cells that have undergone thermal runaway reactions, nor is Exponent aware of any publically available research assessing the effect of such reactions on cell overall heat release rates. Nonetheless, even if a specific cell design is susceptible to a thermite reaction, that reaction will represent only a portion of the resulting fire, such that the use of metal fire suppression techniques will remain inappropriate.

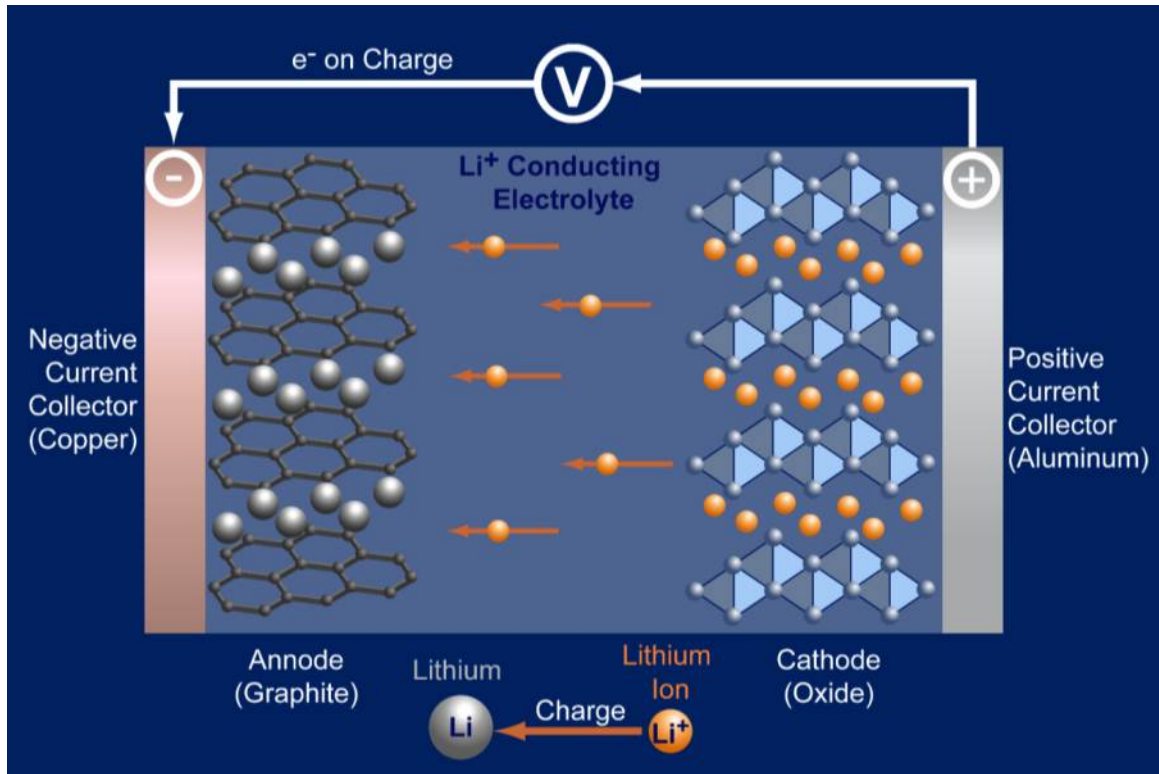

Figure 1 Li-ion cell operation, during charging lithium ions intercalate into the anode, the reverse occurs during discharge

In a Li-ion cell, alternating layers of anodes and cathodes are separated by a porous film (separator). An electrolyte composed of an organic solvent and dissolved lithium salt provides the media for Li-ion transport. A cell can be constructed by stacking alternating layers of electrodes (typical for high-rate capability prismatic cells), or by winding long strips of electrodes into a “jelly roll” configuration typical for cylindrical cells, as shown in Figure 2. Electrode stacks or rolls can be inserted into hard cases that are sealed with gaskets (most commercial cylindrical cells), as shown in Figure 3, laser-welded hard cases, as shown in Figure 4, or enclosed in foil pouches with heat-sealed seams (commonly referred to as Li-ion polymer cells<sup>7</sup>), as shown in Figure 5. A variety of safety mechanisms might also be included in the

<sup>7</sup> Note that the term “lithium polymer” has been previously used to describe lithium metal rechargeable cells that utilized a polymer-based electrolyte. The term lithium polymer is now used to describe a wide range of lithium-ion cells enclosed in soft pouches with electrolyte that may or may not be polymer based.

mechanical design of a cell, such as charge interrupt devices and positive temperature coefficient switches.<sup>8,9</sup>

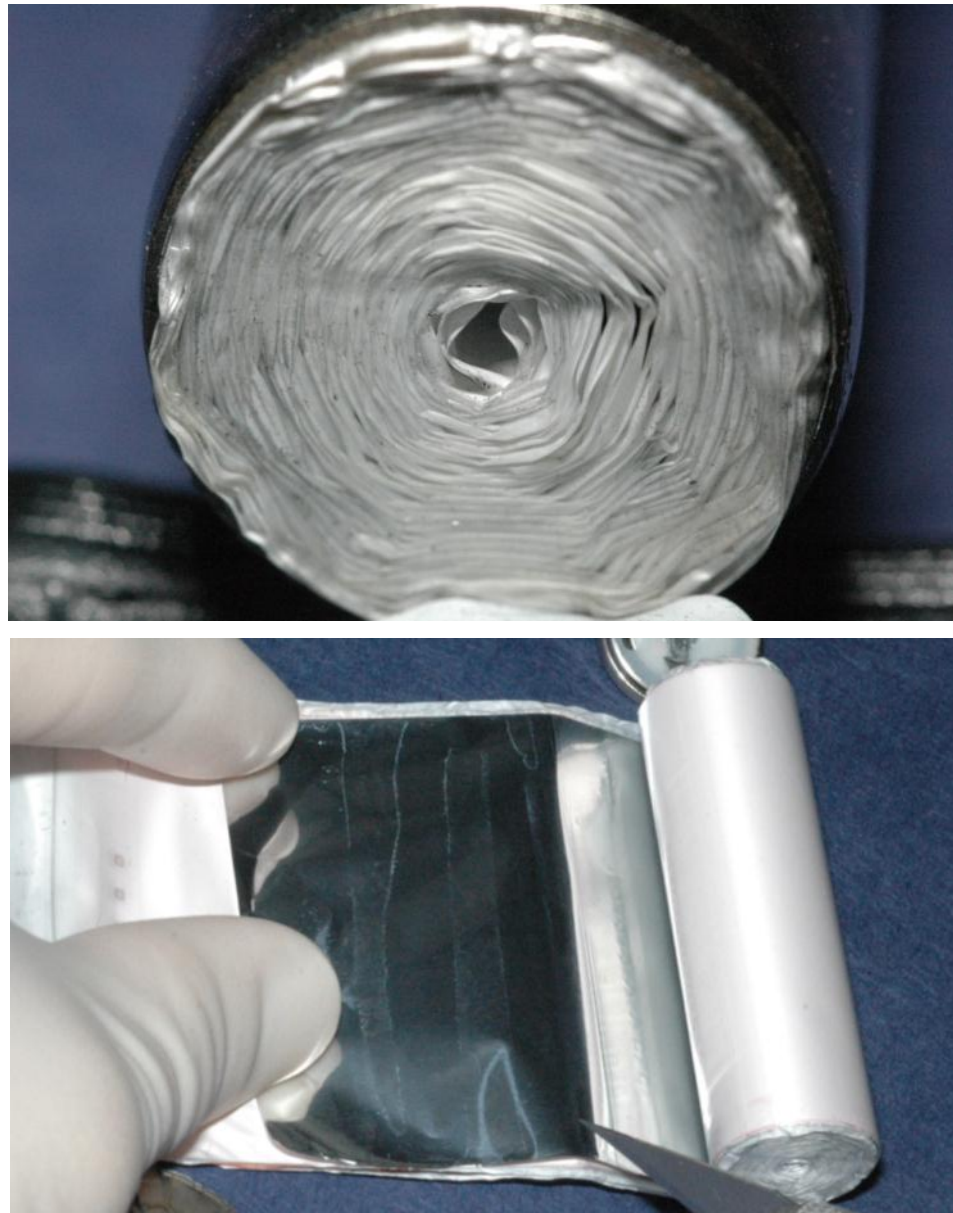

Figure 2 Base of a cylindrical Li-ion cell showing wound structure (top); Cell being unwound revealing multiple layers: separator is white, aluminum current collector (part of cathode) appears shiny (bottom)

---

<sup>8</sup> For a more detailed discussion of Li-ion cells see: Dahn J, Ehrlich GM, “Lithium-Ion Batteries,” *Linden’s Handbook of Batteries*, 4<sup>th</sup> Edition, TB Reddy (ed), McGraw Hill, NY, 2011.

<sup>9</sup> For a review of various safety mechanisms that can be applied to Li-ion cells see: Balakrishnan PG, Ramesh R, Prem Kumar T, “Safety mechanisms in lithium-ion batteries,” *Journal of Power Source*, 155 (2006), 401-414.



Figure 3 Example of 18650 cylindrical cells (these are the most common consumer electronics Li-ion cell form factor)

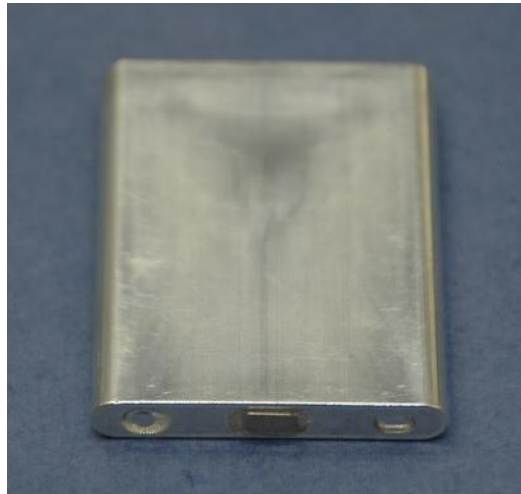

Figure 4 Example of a hard case prismatic cell



Figure 5 Example of a soft-pouch polymer cell

A Li-ion battery is made from multiple individual cells packaged together with their associated control system and protection electronics. By connecting cells in parallel, designers increase pack capacity. By connecting cells in series, designers increase pack voltage. Thus, most battery packs will be labeled with a nominal voltage that can be used to infer the number of series elements and, along with total battery pack energy (in Watt hours [Wh]), can be used to determine the capacity (in Ampere hours [Ah]) of each series element (size of individual cells or the number of cells connected in parallel).

For large format battery packs, cells may be connected together (in series and/or in parallel) in modules. The modules may then be connected in series or in parallel to form full battery packs. Modules are used to facilitate readily changed configurations and easy replacement of faulty portions of large battery packs. Thus, large format battery pack architecture can be complex.

EDV batteries typically utilize many individual cells comprised into modules. The modules are then assembled to form a large format battery pack. Large format packs typically contain an active safeguarding system to monitor electrical current, voltage, and temperature of the cells to optimize pack performance and mitigate potential failures, including fire. Numerous standards and protocols are available for these packs, including, but not limited to:

- Underwriters Laboratories (UL) Subject 2580: Batteries for Use in Electric Vehicles;

- SAE J2464: Electric and Hybrid Electric Vehicle Rechargeable Energy Storage Systems (RESS), Safety and Abuse Testing; and
- SAE J2929: Electric and Hybrid Vehicle Propulsion Battery System Safety Standard – Lithium-based Rechargeable Cells.

It is beyond the scope of this report to discuss all potential standards and protocols; however, a summary of many testing protocols for Li-ion cells has been published previously.<sup>10</sup>

## 2.2 Electric Vehicle Overview

Different types of EDVs are created by unique combinations of the standard components of a hybrid and/or electric vehicle system, including the battery, electric motor, generator, mechanical transmission, and power control system. There are four primary types of EDVs:

1. Hybrid electric vehicles (HEV);
2. Plug-in hybrid electric vehicles (PHEV);
3. Extended-range electric vehicles (EREV); and
4. Battery electric vehicles (BEV).

The following summarizes the four primary types of EDVs and how they commonly function. Some variances will occur from manufacturer to manufacturer. HEVs use a small electric battery to supplement an ICE. The electric battery is recharged by the gasoline engine and regenerative braking. PHEVs are dual-fuel vehicles, where the electric motor and/or the ICE can propel the vehicle. PHEVs use a larger battery pack than HEVs and are charged directly from the power grid to supplement a smaller ICE. EREVs are propelled by electric motors only. When the propulsion battery is depleted, and ICE is used to power an electric generator that provides electricity to the drive motors. Finally, BEVs have no ICE at all and are full EVs. These vehicles must plug into the power grid to recharge.<sup>11</sup>

---

<sup>10</sup> UL: “Safety Issues for Lithium-Ion Batteries,” 2012.

<sup>11</sup> [http://www.tva.com/environment/technology/car\\_vehicles.htm](http://www.tva.com/environment/technology/car_vehicles.htm)

## 2.3 Current EDV Research and Other Efforts

EDVs involved in collision and fire incidents may present unique hazards associated with the high voltage system (including the battery system). These hazards can be grouped into three distinct categories: chemical, electrical, and thermal. The potential consequences can vary depending on, but not limited to, the size, configuration, and specific battery chemistry. Recently the Society of Automotive Engineers (SAE) International released J2990<sup>12</sup>, *Hybrid and EV First and Second Responder Recommended Practice*, which describes the potential consequences associated with hazards from EDVs and suggests common procedures to help protect emergency responders, tow and/or recovery, storage, repair, and salvage personnel after an incident has occurred with an electrified vehicle. Nickel metal hydride (NiMH) and Li-ion batteries used for vehicle propulsion power are the assumed battery systems of this Recommended Practice.

Recently, full-scale fire tests have compared the fire behavior of EDVs with that of conventional ICE vehicles. In the first test series<sup>13</sup>, researchers conducted full-scale tests of an electric battery powered EDV and a comparable ICE vehicle. In this test series, the total HRR of the burning vehicles was calculated using the mass loss rates. The peak HRR of the EDV was found to be approximately three times greater than that of the ICE vehicle; however, given that the EDV and ICE were not identical, it is unclear if the peak HRRs can be directly compared. During the EDV test, no projectiles or explosions were observed. It was noted that while the peak HRR was greater, the total energy released for the EDV was approximately 50% more than the ICE vehicle tested, but 15% less than that of a luxury ICE sedan.

In a second test series<sup>14</sup>, researchers conducted fire tests on two vehicles. The first was an EDV and the second vehicle tested was an analogous ICE vehicle. A gas burner was used to ignite

---

<sup>12</sup> SAE International, Surface Vehicle Recommended Practice J2990 NOV2012, 11-2012, Hybrid and EV First and Second Responder Recommended Practice.

<sup>13</sup> Watanabe, N. et al. "Comparison of fire behaviors of an electric-battery-powered vehicle and gasoline-powered vehicle in a real-scale fire test." National Research Institute of Police Science, Japan. Presented at Second International Conference on Fires in Vehicles, September 27-28, 2012, Chicago, IL.

<sup>14</sup> Lecocq, A. et al. "Comparison of the Fire Consequences of an Electric Vehicle and an Internal Combustion Engine Vehicle." INERIS – National Institute of Industrial Environment and Risks, Verneuil-en-Halatte, France. Second International Conference on Fires in Vehicles, September 27-28, 2012, Chicago, IL.

the vehicles and was located on the front driver's seat. Fire development was similar for both vehicles and no projectiles were observed. The maximum HRR was similar for both vehicles, 4.2 MW for the EDV and 4.8 MW for the ICE vehicle. Gas analysis found that hydrogen fluoride (HF) was emitted in significant quantities in both the EDV and ICE vehicle tests. A distinct area of HF emission was observed during the burning of the EDV that was attributed specifically to the combustion of the EDV battery, however, these peaks were less than the initial and maximum HF peak that was possibly attributed to the air conditioning refrigerant.

Prior work conducted on EDV batteries exposed to pool fires was also reviewed.<sup>15</sup> In this test series, three large format 17 kWh EDV Li-ion batteries were exposed to fuel-fed pool fires in a rack located above an exposure fire. The batteries were not installed in the original host vehicle. The batteries were then extinguished with water and/or water with additives. The battery external temperatures and the total amount of water used were recorded.

The pool fire was placed directly below the battery, was fueled by 45 liters of heptane, and lasted approximately 11 minutes. When exposed to the flames, gases were observed to escape from the battery and produce visible flash fire-like flames and "short circuits" characterized by bright white flames. Water samples collected after extinguishing the batteries showed concentrations of Fluoride and Chloride. Forty (40) to 80 liters of water with various additives were used to extinguish the fire.

The National Institute for Occupational Safety and Health (NIOSH)<sup>16</sup> recently evaluated chemical and particulate exposures to firefighters during vehicle fire suppression training. Smoke samples from engine and cabin fires were collected and analyzed to identify the main chemicals in the smoke. Samples were also collected from the personal breathing zone (PBZ). High levels of hazardous chemicals were found in the smoke samples from the vehicle smoke, however, PBZ samples were below occupational exposure limits (OELs). Recommendations included:

---

<sup>15</sup> Egelhaaf, M., Kress, D., Wolpert, D., Lange, T. et al., "Fire Fighting of Li-Ion Traction Batteries," SAE Int. J. Alt. Power. 2(1):37-48, 2013, doi: 10.4271/2013-01-0213.

<sup>16</sup> Fent, K.W. et al. "Evaluation of Chemical and Particle Exposures During Vehicle Fire Suppression Training." Health Hazard Evaluation Report HETA 2008-0241-3113, NIOSH, Yellow Springs, OH, July 2010.



- Enforcement of the use of self-contained breathing apparatuses (SCBAs) during vehicle fire suppression;
- Attacking fires from upwind positions;
- Parking fire apparatus upwind of the fire;
- Donning SCBA before attacking the vehicle fire; and
- Keeping SCBA on until overhaul is complete.

## 2.4 Overview of Vehicle Fires

Highway vehicle fires are one of the common types of fires to which fire departments respond. However, the number of highway vehicle fires that occur in the United States has been on a steady downward trend since 1980, when NFPA began tracking such incidents. According to NFPA, between 1980 and 1982, there was an average of approximately 447,000 highway vehicle fires per year; between 2009 and 2011, there was an average of approximately 187,500 highway vehicle fires per year.<sup>17</sup> A highway vehicle is defined as a vehicle intended for highway use and is classified as either a passenger road vehicle or truck/freight road vehicle.<sup>18</sup>

Passenger road vehicles are vehicles designed primarily to carry people on roadways. Passenger road vehicles include cars, buses, recreational vehicles, and motorcycles, but this classification does not include pick-up trucks, which are classified as trucks. Automobiles and cars are the most common highway vehicles involved in fires. Between 2003 and 2007, over 70% of highway vehicle fires involved automobiles or cars.<sup>19,20</sup>

Over the past few decades, changes in automobile structural components and interior elements have made modern vehicle fires more challenging. Modern vehicles contain an increased

---

<sup>17</sup> Karter, M. *Fire Loss in the United States 2011*, NFPA Fire Analysis and Research Division, Quincy, MA, September 2012.

<sup>18</sup> Ahrens, M. *U.S. Vehicle Fire Trends and Patterns*. NFPA Fire Analysis and Research Division, Quincy, MA, June 2010.

<sup>19</sup> Ibid.

<sup>20</sup> More detailed information on passenger vehicle fires is available in: Long RT, et al. Passenger vehicle fires. Chapter 1, Section 21. *Fire Protection Handbook*, 20<sup>th</sup> Edition. National Fire Protection Association (NFPA), pp. 21-3–21-14, Quincy, MA, 2008.

amount of plastics and also present other hazards, such as compressed gas struts and absorbers that may explode under fire conditions. Modern vehicles can have components constructed from combustible metals that can react when water is applied. In addition, most vehicles now contain various supplemental restraint systems (SRS), i.e. airbags, to protect passengers during a collision and/or rollover. Airbags can deploy during the removal of crash victims, resulting in firefighter injuries if not properly handled.

Currently, the fire service is searching for ways to manage the recent and forecasted increase in the number and type of EDVs and the potential fires that may result. In addition to the hazards described above, these vehicles may present additional challenges for the fire service. Many of these vehicles have operational features with which fire service personnel are currently unfamiliar. For example, EDVs are normally silent when the vehicle is stopped. Thus an EDV can be “on” and ready to propel itself if the accelerator is depressed. Similarly, many HEVs “hibernate” when they come to a stop. These vehicles are also poised to move if the accelerator is depressed. Emergency responders can no longer assume that a vehicle is “off” when they cannot hear the engine running. However, the Department of Transportation (DOT) / National Highway Traffic Safety Administration (NHTSA) recently issued a Notice of Proposed Rulemaking for a minimum noise level to be added to EDVs, which could reduce or eliminate this issue in the future.<sup>21</sup>

EDVs contain high voltage batteries and electrical components that present a risk of shock or possibly electrocution to first responders if not properly handled. These are hazards not typically encountered during responses to fires in conventional ICE powered highway vehicles. Firefighters could be at risk for severe shock/injury/electrocution if they breach an energized high voltage electrical component or the high voltage battery. Firefighters may also be shocked by coming in contact with an energized high voltage component that has been compromised by fire or collision damage.

---

<sup>21</sup> US DOT/NHTSA recently issued a Notice of Proposed Rulemaking related to the Minimum Sound Requirements for Hybrid and Electric Vehicles (49 CFR 571; Docket No. NHTSA-2011-0148) based on their Draft Environmental Assessment (Docket No. NHTSA-2011-0100), dated January 2013.

## 2.5 Conventional ICE Vehicle Fires

Firefighting practices for conventional ICE vehicle fires have not changed significantly over the past 30 years, although the fire service has adapted to the new hazards presented by modern vehicles, as described previously. Vehicle fires were once treated with relative complacency. Often, firefighters would wear only portions of their PPE ensemble when fighting a vehicle fire. Firefighters rarely took measures to protect themselves from inhaling the smoke and gases emitted from burning vehicles. Increased awareness of hazards associated with modern vehicles, coupled with a more highly developed culture of safety have caused the fire service to demand the use of all safety elements in order to prevent injuries and long term chronic illnesses.

The fighting of fires in modern vehicles may place firefighters at risk of injury from projectiles. Modern vehicles are constructed with various sealed, hollow components that may become pressurized when heated. Shock-absorbing bumpers, drive shafts, and the struts used to raise hoods and hatchbacks can rupture and become projectiles during a fire. It is essential that personnel are completely outfitted in structural turn-out gear to limit the potential for injuries from projectiles.

Another factor that has affected tactics in responding to vehicle fires is the use of plastics in vehicle components. Plastic components are found in nearly every compartment of modern vehicles (i.e. engine, cabin, and cargo area) and on the exterior of vehicles. Plastics can have a higher heat release rate than the products used in the construction of older vehicles. In addition, modern vehicles may have components made of metals that can burn and react with water.

The high heat release rate characteristics of the plastics necessitate the deployment of higher flow rates than might typically have been used in years past. These higher flow rates facilitate faster suppression of the fire and provide a higher level of protection to firefighters. It was common 30 years ago for firefighters to deploy ¾-inch to 1-inch booster lines to combat vehicle fires. Currently, firefighters deploy attack lines of at least 1.5 inches in diameter on vehicle fires, as recommended by the International Fire Service Training Association (IFSTA). IFSTA also recommends not relying on booster lines as they, "...do not provide the protection or rapid

cooling needed to effectively and safely fight a vehicle fire.” In addition, IFSTA encourages the deployment of a back-up line as soon as possible.<sup>22</sup>

The increased use of plastics and other materials, combined with a much clearer understanding of the detrimental health effects associated with vehicle fires has also resulted in changes to tactics. In the past, it was uncommon for firefighters to wear an SCBA while extinguishing a vehicle fire. A rising awareness of the vast array of volatile organic compounds (VOCs) and other gases emitted during a vehicle fire and their associated potential health effects have made the donning of SCBAs essential at every vehicle fire.<sup>23</sup>

## **2.6 Current Conventional ICE Vehicle Fire Tactics**

In order to examine how the prevalence of EDVs should influence tactical operations at vehicle fires, it is important to look at how, in general, fires in conventional ICE vehicles are being extinguished currently. The following is a list of tasks in chronological order, typically performed at a vehicle fire. The operations described below assume there are at least four fire service personnel on scene. If fewer personnel are present, all of the tasks still must be performed by those personnel on scene.<sup>24</sup>

1. Upon arrival of the pumper(s), the apparatus is parked at least 50 feet from the burning vehicle, in such a position as to protect firefighters from vehicular traffic.
2. Firefighters (FF1 and FF2) and officer wear full PPE and SCBA. The pumper operator (FF3) is usually not in full PPE.
3. The officer performs a 360-degree size-up to identify hazards and determine if there are trapped occupants or injured civilians. The officer directs the firefighters throughout the extinguishment.

---

<sup>22</sup> IFSTA. Essentials of Fire Fighting. Stillwater, OK: Fire Protection Publications. 2008.

<sup>23</sup> Fent, K. and Evans, D. Assessing the risk to firefighters from chemical vapors and gases during vehicle fire suppression. 2010.

<sup>24</sup> These tactics are the basic vehicle fire operations known to MFRI.

4. The firefighters stretch an attack line (1-1/2" or 1-3/4") from the first arriving pumper. At this point, they don their SCBA (attach facemask to face and begin breathing off cylinder air), if they had not already done so.
5. The officer advises the firefighters of any observed hazards, victims, etc.
6. FF3 charges the attack line with water from the pumper's water tank.
7. FF1 opens the nozzle's bale and adjusts the stream of the nozzle. FF1 advances toward the vehicle with a wide pattern (60° fog) from uphill/upwind if possible, approaching toward one of the vehicles corners or the side of the vehicle, but not from the front or rear of the vehicle. The main priority of FF1 is to protect anyone who may be trapped in the vehicle.
8. FF2 or the officer chocks a wheel of the vehicle to prevent it from rolling as FF1 approaches the vehicle.
9. If the fire is in the passenger compartment and the window(s) have already failed, FF1 narrows the pattern to a 30° fog and directs the stream at close range into the cabin of the burning vehicle. If the windows have not failed, FF2 attempts to open the vehicle's door with the door handle. If the doors are locked, FF2 uses a forcible entry tool to smash the vehicle's window(s). FF1 can then direct the stream into the cabin.
10. If the fire is in the engine compartment, FF1 may direct the 30° fog stream up through the wheel-wells, through the grill, or under the hood from the base of the windshield. FF2 attempts to release the hood latch from the cabin of the vehicle and raise the hood. If the hood release will not work, FF2 may use a prying tool to create a gap between the hood and the fender through which the stream can be directed. Some departments utilize piercing nozzles that can be spiked through the hood to flow water into the engine compartment.
11. As fire in the engine compartment is knocked down, FF2 begins to force entry into the engine compartment by smashing/prying the hood lock/clasp or by using other tools to pry the back corners of the hood up and cut through the hood's hinges. Some departments use powered saws to cut a hole in the hood.

12. Access to a fire burning in the trunk area may be gained using methods similar to those described for forcing entry to the hood. In some instances, a firefighter may be able to drive-in the trunk lock with a forcible entry tool and pick the disabled locking mechanism with a screwdriver.
13. FF1 moves around the vehicle with the attack line to access all burning areas of the vehicle. All visible fire is extinguished.
14. FF2 accesses the compartment housing the vehicle battery and cuts or disconnects the negative (ground) cable from the battery terminal (or both cables from both terminals), to prevent a shorted electrical system from reigniting a fire. This step is repeated if the vehicle has a second battery.
15. The firefighters and officer overhaul the vehicle to ensure the fire is completely extinguished by opening areas where fire may be hidden and/or smoldering; these areas are thoroughly soaked.
16. The officer does an investigation to determine the fire's origin and cause. The officer may call for a fire investigator if the cause is undetermined, incendiary, or suspicious.

## 2.7 Current EDV Fire Tactics

Firefighters are confronted with additional hazards and challenges when dealing with EDVs. The following best practices address EDV fires.<sup>25,26,27</sup> The operations described below do not state how many fire service personnel will be on scene. However many are present, all of the tasks still must be performed by those personnel on scene. These tasks include:

1. Identify the vehicle;
2. Immobilize the vehicle;
3. Disable the vehicle;

---

<sup>25</sup> National Fire Protection Association. Electric Vehicle Emergency Field Guide. Quincy, MA. 2012.

<sup>26</sup> National Highway Traffic Safety Administration. Interim Guidance for Electric Vehicle and Hybrid-Electric Vehicles Equipped With High Voltage Batteries. Washington, D.C. 2012.

<sup>27</sup> SAE International, Surface Vehicle Recommended Practice J2990 NOV2012, 11-2012, Hybrid and EV First and Second Responder Recommended Practice.

4. Extrication;
5. Extinguishment; and
6. Overhaul operations.

### **2.7.1 Identify the Vehicle**

Identification of a vehicle as an EDV is the first challenge firefighters face upon arriving at a vehicle fire. It must become part of every firefighter's size-up operations to determine if a burning vehicle is an EDV. In many instances, it may be readily apparent from the vehicle make/model or from exterior badges/logos. In other instances, it may not be so apparent. Damage sustained by the vehicle by either a collision/roll-over or the fire and smoke itself may make identification very difficult. During size-up of the incident, firefighters should look for warning labels on the EDV that warn of high voltage. Some labels may be less direct at communicating the fact that the vehicle in question is an EDV.

If the fire is confined to the engine compartment or trunk, a firefighter may be able to get a clear view of the instrumentation on the vehicle's dashboard. In this case, firefighters should look for words and symbols that indicate the vehicle is an EDV. If the vehicle is "on", the firefighter may be able to see dash symbols indicating charge status of the battery, or that there isn't a fuel gauge.

Whatever method is used to identify the vehicle, all personnel operating at the scene must be made aware if the vehicle on fire is an EDV.

### **2.7.2 Immobilize the Vehicle**

As with conventional ICE vehicles, it is important to place chocks to the front and rear of one of the wheels to prevent the vehicle from rolling. EDVs can hibernate; although it may not be obvious that the engine is running, the vehicle may be poised to move as soon as the accelerator is depressed. EDVs should be chocked to prevent any inadvertent movement of the vehicle as soon as possible. Although a good preventative measure, chocking alone may not prevent

movement if the drive system is engaged. If possible, setting the emergency brake and placing the vehicle in park can add additional protection against inadvertent movement.

### **2.7.3 Disable the Vehicle**

Determine the status of the vehicle by viewing the dash display, the position of the key in the ignition, and/or the power button to see if it has a lit indicator light. If the vehicle is “on”, turn the key to the “off” position. Some new EDVs operate with a proximity key. If the proximity key is within range of the vehicle (usually less than 16 feet), the vehicle is powered “on” by a button on the dash. Turn the vehicle “off” by pressing this button. Then remove the key from the ignition and place it beyond the range of the vehicle (typically greater than 16 feet).

In addition to the high voltage battery that powers an EDV motor, there is a conventional 12-volt battery located somewhere on the vehicle. The 12-volt battery powers many of the vehicle accessories and is used to control high voltage contactors. Severing the 12-volt battery’s ground cable will prevent the vehicle from powering up. Cutting the 12-volt battery in a vehicle that is “on”, however, will not turn the vehicle “off”, as power supplied by the DC/DC convertor may keep the contactor closed. After the vehicle has been powered down by the key/ignition button, firefighters should further disable the vehicle by severing the 12-volt battery’s negative ground cable. The officer should refer to NFPA’s *Electric Vehicle Emergency Field Guide* or other appropriate guides for vehicle specific information on the location of the 12-volt battery and fuses that can be pulled to disable the high voltage system.

If firefighters are unable to gain access to the area housing the 12-volt battery or fuses, they may attempt to isolate the high voltage system by removing or switching off the high voltage main disconnect (or “high voltage service disconnect”). Firefighters will need a guide, such as NFPA’s *Electric Vehicle Emergency Field Guide*, in order to determine the location of the high voltage main disconnect and identify the proper method for de-energizing the system. Firefighters may not be able to complete this step until after the fire is extinguished.<sup>28</sup> Further detail on recommendations for high voltage system disabling can be found in SAE International Recommended Practice J2990. J2990 recommends that vehicle manufacturers provide a

---

<sup>28</sup> Delphi Corporation. Hybrid Electric Vehicles for First Responders. Troy, MI. 2012.



minimum of two methods of initiating the disconnection of the propulsion system from the high voltage sources. Utilizing more than one method increases the likelihood that the high voltage sources have been disconnected. SAE recommends the following methods of initiating the disconnection in their preferred order:

1. Automatic shutdown of the high voltage system based on the detection of a prescribed level of vehicle impact;
2. Switching the ignition switch or power button to the “off” position (assuming there is no damage to the shutdown circuits or high voltage discharge circuits);
3. Cutting or disconnecting the negative and positive 12-volt battery cables to discharge the 12-volt system while also cutting or disconnecting the DC/DC converter’s 12-volt output cable; and/or
4. Removing the manual disconnect. However, this was listed as not being a primary method for first responders to disable the vehicles high voltage circuits, as there are a variety of manual disconnect designs and locations.

Firefighters assigned the task of disabling the high voltage system via the main should consider wearing Class 0/1000v high voltage safety gloves with outer leather covers. However, a review of a selection of automotive manufacturer requirements for electrical PPE showed significant variations according a recent NFPA workshop.<sup>29</sup> This workshop also highlighted that there are significant differences between PPE used by the fire service and electrical professionals when handling energized electrical equipment.

It may take up to ten minutes for a high voltage system to dissipate its energy after the main has been pulled/switched off. However, it should be noted that high voltage will still be present within the battery pack and on the battery pack side of the high voltage main disconnect switch.

Should the EDV be plugged into a charging station at the time of a fire, the best practice would include isolating the electrical supply to the charging station at a safe location by trained professionals prior to any attempts at disabling the high voltage system within the vehicle.

---

<sup>29</sup> Emergency Responder Personal Protective Equipment (PPE) for Hybrid and Electric Vehicles May 1, 2012.

## **2.7.4 Extrication**

Upon arrival at an incident involving the extrication of victims from an EDV, response personnel should use the steps identified above to immobilize and disable the vehicle. Due to the degree of damage to the vehicle and/or the physical aspect of the vehicle, responders may have to employ secondary methods for disabling the vehicle, as described above. The supplemental restraint systems in most vehicles will remain active if the 12-volt batteries are not disconnected.

A damaged high voltage battery may emit corrosive, toxic, and flammable fumes. If responders become aware of unusual odors and/or sense irritation of their eyes, nose, or throat, they should don PPE and SCBA. In addition, responders should use ventilation techniques to protect the occupants of the vehicle and prevent the build-up of flammable vapors in the trunk or passenger compartment.

A charged attack line should be staged in close proximity to the vehicle during extrication. Responders should constantly monitor for indications that a damaged battery may be overheating, such as sparking, smoking or making bubbling sounds.

Throughout stabilization and extrication, response personnel must avoid inadvertent contact with all high voltage cabling and high voltage components. Response personnel should never cut through any high voltage electrical component. Personnel performing the extrication should visually check for the presence of high voltage electrical cabling and components of the supplemental restraint system prior to initiating every cut or displacement (e.g. pry). The location and routing of high voltage components may prevent some advanced extrication techniques, such as trunk tunneling and gaining access through the underside or floor pan of the vehicle.

## **2.7.5 Extinguishment**

Fires confined to the cabin or trunk of an EDV can be extinguished using tactics associated with conventional vehicles. EDVs contain the same polyvinyl chlorides, polyurethanes, and reactive

metals as conventional vehicles, as well as the previously discussed projectile hazards. Firefighters should be in full PPE with SCBA donned.

Firefighters must avoid contact with any orange electrical cables and components that have high voltage warning labels. If a fire has burned warning labels or rendered them otherwise illegible, firefighters should not touch any electric drive or drive system component. Firefighters should never attempt to breach a high voltage battery or its casing for any reason.

Fires in the engine compartment of an EDV may require different tactics. Many high voltage components are directly accessible from the engine compartment. Defensively applying a fog stream through existing openings in the wheel-wells and grill can be done safely to knock down the fire. Firefighters should not attempt to force entry into the engine compartment with prying tools, nor should they attempt to spike or cut the hood or fenders with a piercing nozzle, cutting tool, or prying tool. Performing any of these tasks could result in a firefighter being severely shocked or electrocuted.

It may be the case that firefighters are unable to gain access to the engine compartment. In this instance, defensive fire suppression tactics should be employed until the fire is completely extinguished.

If there are no exposures and the fire involves the high voltage battery, currently defensive tactics are recommended. Because of the potential difficulty of applying a sufficient amount of extinguishing agent to a burning high voltage battery, the incident commander may allow the vehicle to burn itself out. If the high voltage battery is involved in the fire, an offensive attack may be recommended if there are exposures (other vehicles, buildings, etc.). If the high voltage battery is not involved in the fire, an offensive attack may be mounted regardless of whether there are exposures.

### **2.7.6 Overhaul Operations**

Following extinguishment, the EDV must be properly overhauled. Responders should first verify the vehicle has been properly immobilized and disabled, and take appropriate steps to

accomplish these tasks if they have not been completed. As during all phases of any response to incidents involving an EDV, responders must avoid contact with any high voltage component during the overhaul phase of the incident. Responders should never attempt to cut, breach or remove the high voltage battery or any high voltage component. Diligent thought and care should be exercised before manipulating the EDV in any way with any forcible tools.

During overhaul, firefighters will verify that the fire has been completely extinguished. Firefighters should not drive prying tools into any area that may house or cover high voltage components. Firefighters should also carefully observe the high voltage battery compartment to ensure it is not smoking, sparking, or making bubbling sounds. A thermal imaging camera may be used to assess the temperature of the battery and to assist in determining if it is producing heat.

Responders should contact a dealer/manufacturer representative to de-energize the high voltage battery (if possible) and to determine the final disposition of the vehicle. Responders should advise the company recovering the vehicle that it is an EDV, and advise them not to store the vehicle inside a structure or within 50 feet of a structure or other vehicle in accordance with current NFPA guidance. EDVs should be recovered on a flatbed truck.

## **2.8 High Voltage Battery Fires**

Fires may occur in an EDV high voltage battery, or a fire may extend to the battery. Most EDV batteries currently on the road are NiMH.<sup>30</sup> However, the number of cars powered by Li-ion batteries is increasing. These batteries may exhibit different burning characteristics and react differently to heat exposure. There is very little literature concerning recommended tactics for EDVs in which the battery is burning. Some literature encountered during this review is contradicted by other literature, demonstrating that further testing and research, such as in this testing program, is needed.

To show the variation in reviewed literature regarding high voltage battery fires, some excerpts of the literature are quoted below.

---

<sup>30</sup> Delphi Corporation. Hybrid Electric Vehicles for First Responders. Troy, MI. 2012.

The NFPA's *Electric Vehicle Emergency Field Guide*<sup>31</sup> states the following:

*The use of water or other standard agents does not present an electrical hazard to firefighting personnel.*

*If an HV battery catches fire, it will require a large, sustained volume of water.*

*If Li-ion HV battery is involved in fire, there is a possibility that it could reignite after extinguishment. If available use thermal imaging to monitor the battery. Do not store a vehicle containing a damaged or burned Li-ion HV battery in or within 50ft. of a structure or other vehicle until the battery can be discharged.*

The Fire Protection Research Foundation report, *Fire Fighter Safety and Emergency Response for Electric Drive and Hybrid-Electric Vehicles*<sup>32</sup> states:

*Dry chemical, CO<sub>2</sub>, and foam are often the preferred methods for extinguishing a fire involving batteries, and water is often not the first extinguishing agent of choice.*

*Another important consideration with an EV or HEV fire is that the automatic built-in protection measures to prevent electrocution from a high voltage system may be compromised. For example, the normally open relays for the high voltage system could possibly fail in a closed position if exposed to heat and if they sustain damage. Further, short circuits to the chassis/body may become possible with the energy still contained in the high voltage battery or any of the high voltage wiring still connected to the battery.*

Delphi Corporation's, *Hybrid Electric Vehicles for First Responders*<sup>33</sup> states:

*Firefighting techniques for vehicles using Li-ion battery packs should be treated like any electrical fire by using Class C extinguishing agent.*

*Initial attack on hybrid HEV battery pack fires: perform a fast aggressive attack.*

*Should a fire occur in the NiMH high voltage battery, attack crews should utilize a water stream or fog pattern to extinguish any fire within the trunk. The incident commander*

---

<sup>31</sup> National Fire Protection Association. *Electric Vehicle Emergency Field Guide*. Quincy, MA. 2012.

<sup>32</sup> Grant, C. *Fire Fighter Safety and Emergency Response for Electric Drive and Hybrid Electric Drive Vehicles*. Quincy, MA. 2010.

<sup>33</sup> Delphi Corporation. *Hybrid Electric Vehicles for First Responders*. Troy, MI. 2012.

*should make the call on whether to perform an offensive or defensive fire attack in the area around the HEV battery pack.*

The National Highway Traffic Safety Administration's publication, *Interim Guidance for Electric and Hybrid Electric Vehicles Equipped with High Voltage Batteries*<sup>34</sup> states:

*If the fire involves the lithium-ion battery, it will require large, sustained volumes of water for extinguishment. If there is no immediate threat to life or property, consider defensive tactics, and allow the fire to burn out.*

Based on the above, currently there is no consensus on best practices for extinguishing EDV battery pack fires. Preliminary results<sup>35,36</sup> indicate that water can be an effective extinguishing agent on both NiMH and Li-ion batteries; however, none of the literature reviewed indicated the level of shock/electrocution hazard from directly applying a water stream to an energized high voltage battery that has been compromised by heat and fire. Furthermore, some of the testing was conducted by applying water directly on EDV batteries that were free standing (not installed in vehicles). While these test showed that water was an effective extinguishing agent, it may be difficult to flow large volumes of water on a battery that is actually installed in/under the vehicle.

## **2.9 Summary**

Current versions of various firefighting guidelines are consistent with each other regarding first responder firefighting tactics to immobilize/disable the vehicle. However, a new step for first responders has been identified when comparing tactics for conventional ICE vehicles and EDVs. This involves identifying whether or not the vehicle is an EDV. Firefighters typically will not know what type of vehicle is involved before they arrive at the scene of the incident or the type of vehicle may not be obvious once they arrive and begin their tactics. As such,

---

<sup>34</sup> National Highway Traffic Safety Administration. *Interim Guidance for Electric Vehicle and Hybrid-Electric Vehicles Equipped With High Voltage Batteries*. Washington, D.C. 2012.

<sup>35</sup> Egelhaaf, M. and Kreß, D. *Fire Fighting of Li-Ion Traction Batteries*, DEKRA Automobil GmbH, SAE International, 2012

<sup>36</sup> Delphi Corporation. *Hybrid Electric Vehicles for First Responders*. Troy, MI. 2012.

performing the same practices for all vehicle fires would ensure that first responders are acting safely and appropriately regardless of the type of vehicle involved in the incident.

In regards to suppression, in most instances, available literature suggests that the application of water can extinguish EDV fires, as is the case with most fires in conventional ICE vehicles. However, it may be difficult to apply a sufficient flow of water to a burning battery installed in/under a vehicle with the tools currently available to the fire service.

In most EDVs, the battery is located in the chassis, housed in a plastic or metal shell. In these cases, water may not be sufficient to achieve full extinguishment, but rather the water may serve as a medium to transfer heat and cool the battery and cell components as thermal runaway subsides and or is interrupted by the application of water.

Based on a review of the literature, the final topic that requires further research is the electrical hazard presented by burning vehicle batteries. Some of the literature<sup>37</sup> reviewed suggests that a burning EDV battery has the potential to discharge electrical energy to the frame and body of the vehicle. Furthermore, the application of water streams to burning EDVs at close range may also become recognized as an unacceptable practice, if it is found that the potential for high voltage shock exists.<sup>38</sup>

---

<sup>37</sup> Grant, C. Fire Fighter Safety and Emergency Response for Electric Drive and Hybrid Electric Drive Vehicles. Quincy, MA. 2010.

<sup>38</sup> Backstrom, R. et al. "Firefighter Safety and Photovoltaic Installations Research Project." Underwriters Laboratories, Northbrook, IL, November 29, 2011.

### 3 Testing Program Summary

---

Exponent, in conjunction with the Project Technical Panel and their advisory groups, identified three different battery assemblies for full-scale testing. The three batteries procured were different in size and vehicle installation position to simulate the varying hazards emergency responders could face in the field depending on the automobile manufacturer. A more detailed description of each battery is provided in Section 4.

The full-scale fire tests were separated into two categories: (1) free burn, unsuppressed HRR testing of a standalone battery pack and (2) full-scale suppression testing of a battery pack in its correct mounting location positioned inside a VFT, along with other appropriate combustible materials, including vehicle interior finishes.

Once the battery fire self-extinguished, as in the case of the unsuppressed fire, or extinguished, as in the suppressed fires, Exponent continued to monitor the batteries visually and through a combination of thermal imaging and thermocouple temperature measurements. This was performed to provide data on the safe handling of post-fire batteries for fire responders and those involved in overhaul and storage.

The free burn, unsuppressed HRR test was performed on one standalone battery. Data collected during this test included:

- HRR;
- Products of combustion (gas sampling);
- Temperatures;
- Heat fluxes;
- Projectile observations;
- Battery internal temperature;
- Battery internal cell voltage measurements;



- Thermal imaging;
- Still photography; and
- High definition video.

The full-scale fire suppression tests were performed in conjunction with MFRI and their firefighter training staff. Data collected included:

- Temperatures;
- Heat fluxes;
- Projectile observations;
- Suppression water sampling;
- Volume of suppression water flow;
- Nozzle voltage and current measurements;
- Chassis voltage and current measurements;
- Battery internal temperatures;
- Battery internal cell voltage measurements;
- Thermal imaging;
- Still photography;
- High definition video; and
- MFRI staff / firefighter observations.

Battery packs were tested in the configuration and arrangement as they would be located within the actual vehicle. To ignite the battery packs, an external gas burner system was used. The gas burners were located under the vehicle to simulate a moderate size gasoline pool fire underneath the battery pack.

A detailed description of these measurements, the test setups and the test protocols for each test series is provided in Section 5.

## 4 Battery Descriptions

---

In conjunction with NFPA's FPRF and the Project Technical Panel, Exponent procured batteries from two car manufacturers for testing, designated Battery A and Battery B.<sup>39</sup> Both of the batteries procured were based on a Li-ion technology are currently being used in production vehicles in the United States. Battery A is a 4.4 kWh battery that is installed under the rear cargo compartment of the vehicle. Battery B is a 16 kWh battery that is installed under the vehicle floor pan and spans nearly the length of the vehicle from the rear axle to the front axle in a T-shaped configuration. Battery A and Battery B span a wide spectrum of battery sizes and vehicle installation positions to simulate the varying hazards emergency responders could face in the field during actual EDV fire incidents.

As part of the agreement with the vehicle manufacturers who graciously donated batteries, the EDV batteries were not opened, altered, or manipulated prior to, during or after the fire tests. The designs, descriptions, and details of the batteries in the following sections were provided to Exponent by the vehicle manufacturers, as well as from publically available information sources.

### 4.1.1 Battery A

Battery A is designed for a PHEV and features a large capacity high voltage hybrid vehicle (HV) battery assembly that contains sealed Li-ion battery cells. The 4.4 kWh HV battery pack is enclosed in a metal case (see Figure 6) and is rigidly mounted in the lower portion of the rear cargo area behind the rear seat, as shown in Figure 7. The metal case is isolated from high voltage and concealed and separated from the passenger compartment by a molded plastic cover with carpeting, as shown in Figure 8. The electrolyte used in the Li-ion battery cells is a flammable organic electrolyte.

---

<sup>39</sup> Three (3) approximately 10 kWh Li-ion batteries were procured in addition to Battery A and Battery B from a third manufacturer. However, once procured, the battery packs were found to have significant anomalies and damaged cells, which presented significant safety hazards associated with handling and charging the battery packs. Therefore, these batteries were not included in the test program.

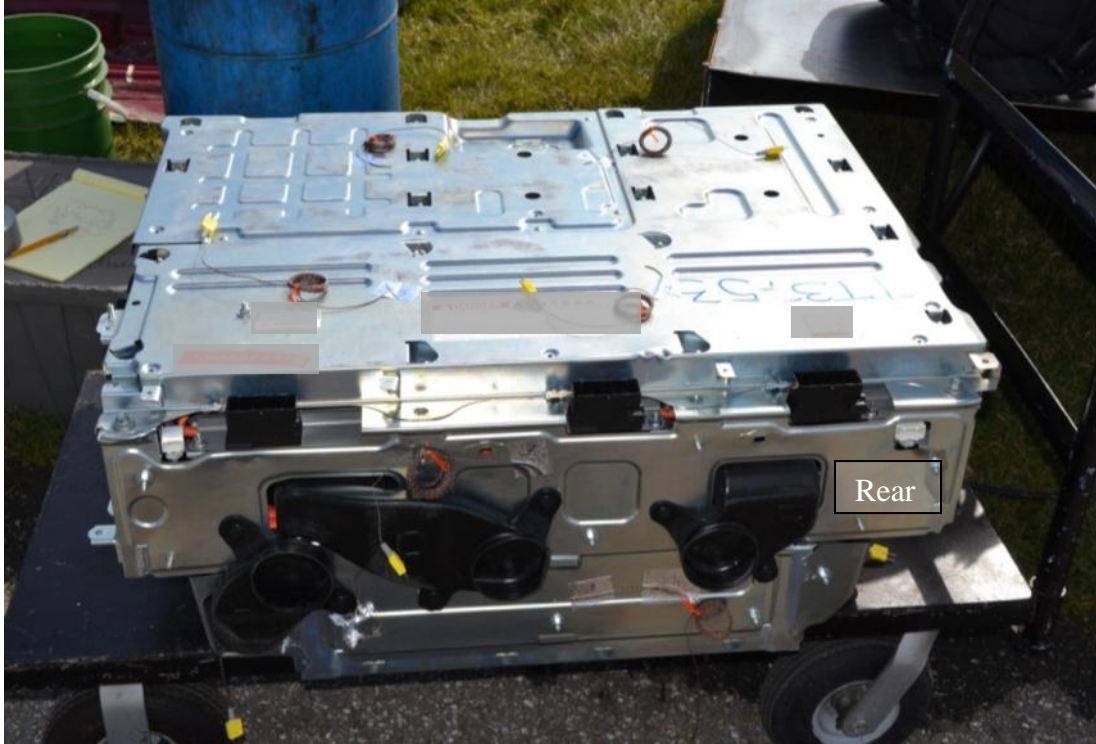

Figure 6 Battery A



Figure 7 Battery A cargo area over the battery compartment



Figure 8 Battery A compartment in cargo area with carpet and molded plastic cover removed

#### **4.1.2 Battery B**

Battery B is designed for an EREV and features a battery assembly that contains sealed Li-ion battery cells. The 16 kWh battery pack sits on top of a steel plate and is enclosed in a fiberglass case, as shown in Figure 9. The T-shaped battery spans nearly the length of the vehicle from the rear axle to the front axle and is rigidly mounted underneath the vehicle floor pan, as shown in Figure 10. A vehicle passenger compartment floor pan separates the battery assembly from the passenger compartment. The electrolyte used in the Li-ion battery cells is a flammable organic electrolyte.

Rear



Forward

Figure 9 Battery B

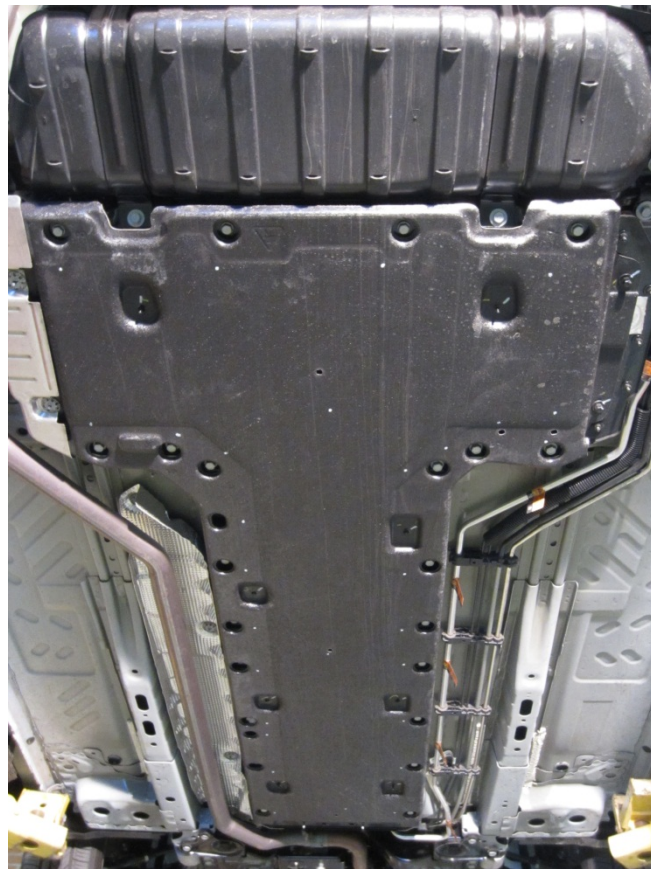

Figure 10 Battery B installed in vehicle

## 5 Test Setup

---

The full-scale fire tests were separated into two categories: (1) HRR testing and (2) full-scale fire suppression testing. The test setup for each phase of the project is described herein.

The overall intent of the testing is to provide a repeatable scientific experiment that evaluates water-based suppression of an EDV fire. The data generated will then be used to answer many of the questions first responders have regarding EDV fires. In addition, the data will facilitate any necessary revision to the NFPA training materials for first responders regarding how to safely and efficiently extinguish EDV fires while highlighting how these fires are different from those involving traditional ICE vehicles. The following are key assumptions related to the testing:

- The EDV batteries were tested at a 100% SOC.
- The suppression tests were conducted in a modified VFT capable of housing the different manufacturer battery packs.

### 5.1 HRR Testing

The full-scale HRR testing was performed at Southwest Research Institute (SwRI) in San Antonio, Texas.<sup>40</sup> The objective of the HRR testing was to determine the amount of energy released from the battery alone when it was ignited by an external ignition source. The secondary objective of the testing was to verify the battery could be induced into thermal runaway with the external ignition source (propane fueled burners positioned beneath the battery) for use during the full-scale fire suppression tests and to collect data as to the indications that the battery was experiencing thermal runaway. Due to a limited number of batteries available for the project, only one standalone battery pack was designated for HRR testing from the Battery B sample set. Data collected during this test included:

- HRR;

---

<sup>40</sup> SwRI is one of the oldest and largest independent, nonprofit, applied research and development organizations in the United States. The Fire Technology Department is one of the world's largest organizations dedicated to fire research and testing.

- Products of combustion (gas sampling);
- Temperatures;
- Heat fluxes;
- Projectile observations;
- Battery internal temperature;
- Battery internal cell voltage measurements;
- Thermal imaging;
- Still photography; and
- High definition video.

SwRI was responsible for providing the facility for the fire test and performing the following analyses:

- HRR measurements using oxygen calorimetry;
- Products of combustion by collecting gas samples and analyzing the gas using Fourier transform infrared spectroscopy (FTIR);
- Temperature measurements using thermocouples;
- Heat flux measurements using heat flux gauges;
- Test observations;
- Still photography; and
- High definition video recording.

The full SwRI report detailing these measurements is provided in Appendix A.

Exponent was responsible for the following:

- Test observations;
- Still photography;



- High definition video recording;
- Providing and controlling the external burner assembly;
- Internal battery cell voltage and temperature measurements through direct communication with the battery; and
- Thermal images of the battery during and after the test.

### 5.1.1 Battery Positioning

Battery B was centered under a 20 foot by 20 foot hood supported by five stainless steel legs, as shown in Figure 11 and Figure 12. The leg supports held the battery in place, twenty inches above the ground to provide a viewing angle to the bottom of the battery during testing.



Figure 11 Battery B configuration and burner locations for HRR testing



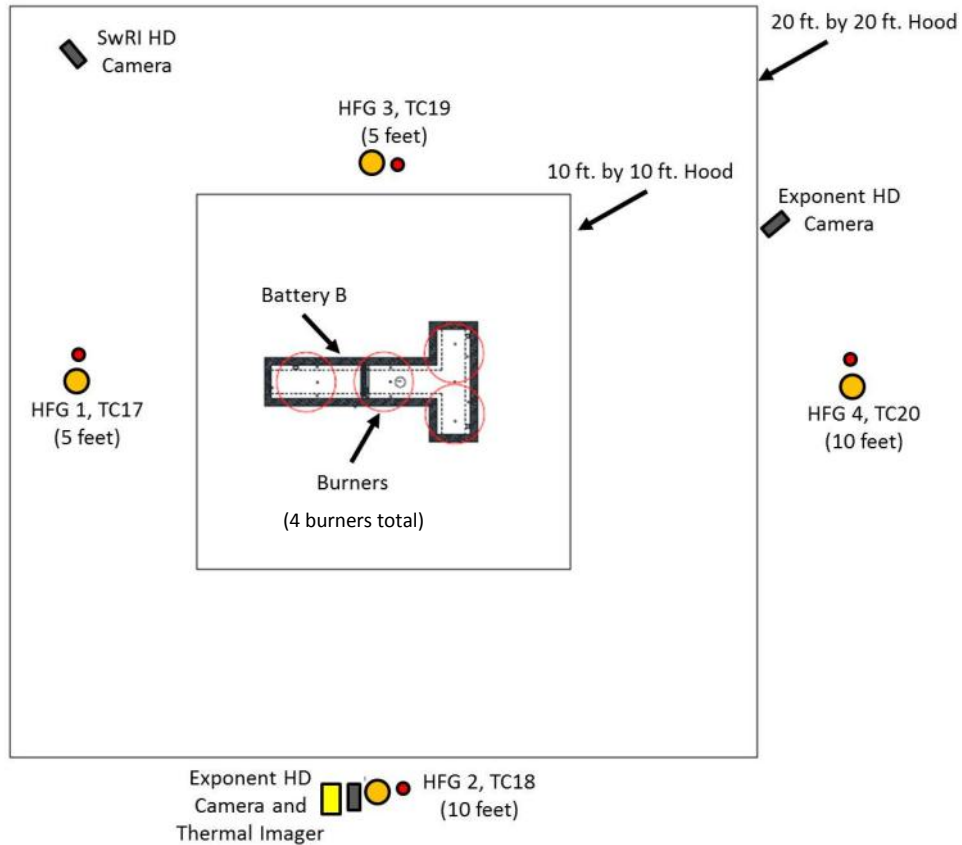

Figure 12 Layout and arrangement of the HRR testing perimeter instrumentation

### 5.1.2 Burner Description

As part of the agreement with the vehicle manufacturers, the EDV batteries were not to be opened, altered, or manipulated internally prior to, during, or after testing. This included ignition of the batteries during testing. As such, an external ignition source was chosen. Fires occurring from some type of internal cell fault are therefore outside the scope of this project. Given that EDVs are still a small percentage of the marketplace, a collision involving an EDV and an ICE vehicle was considered a possible scenario. Based on a review of NFPA data on vehicle fire risk<sup>41</sup>, flammable or combustible liquids or gases were the first item ignited in 31% of U.S. highway vehicle fires, resulting in 70% of civilian deaths, 58% of civilian injuries, and 31% of the direct property damage. As such, a pool fire scenario under the EDV was selected

<sup>41</sup> Ahrens, M. "U.S. Vehicle Fire Trends and Patterns." National Fire Protection Association, Quincy, MA; June 2010.

as the likely ignition scenario where the batteries become near fully involved and “burning on their own.”

While previous tests were successful in burning the batteries with a pool fire exposure, a pool fire ignition source is not easily “throttled” or “turned off.” As such, four propane-fueled gas burners were utilized as the external ignition source in this test series to induce the batteries into thermal runaway. Propane fueled burners were chosen to allow for definitive control of the exposure and repeatability, as well as to allow for turning off the exposure once the battery was in thermal runaway so that the “battery only” scenario fire could be evaluated.

The burner assembly comprised three main sections: fuel supply, fuel control, and burners, as shown in Figure 13 and Figure 14 and listed in Table 1. Propane gas was supplied from two 100-gallon (400 lb.) capacity cylinders and regulated to a working pressure of up to 35 psi. The gas cylinders were connected to the fuel control section via 9/16-inch hoses, which fed into a 1-inch stainless steel pipe section, a 1-inch manual shutoff valve and a 1-inch electric-powered solenoid valve (ASCO Model HV285926002), respectively.

Table 1 Burner Assembly Components

Burner Assembly Component	Figure 13 / Figure 14 Number
Fuel Supply:	
100 gallon (400 lb.) propane cylinders	1
9/16-inch diameter hoses	
1-inch diameter stainless steel piping	
Fuel Control:	
1-inch manual shutoff valve	2
1-inch solenoid valve	3
1-inch mass flow controller	4
DAQ	8
Burners:	
1/4-inch manual burner isolation valve	5
Second stage regulator and 1/4-inch stainless steel braided hose	6
19-inch diameter burners	7

Downstream of the solenoid valve, a mass flow controller (Bronkhorst M+W Model D6383, with  $\pm 2\%$  accuracy) was instrumented to allow for measurement and control of the LP-gas mass supply rate. The solenoid valve and the mass flow controller were controlled by a data acquisition system (DAQ), which is discussed in Section 5.1.7. All sections of pipe between the manual shutoff valve, solenoid valve and mass flow controller were 1-inch and constructed of stainless steel.

From the outlet of the mass flow controller, LP-gas continued via 1-inch stainless steel piping to a four-outlet manifold, allowing for simultaneous operation of up to four (4) burners. From each of the manifold outlets, a  $\frac{1}{4}$ -inch manual isolation valve and a second stage regulator are instrumented, respectively. A  $\frac{1}{4}$ -inch flexible stainless steel braided hose 40 feet in length was used to connect the outlet of the second stage regulator to a circular, 19-inch diameter gas burner containing eighty-eight (88) 0.30-inch diameter nozzles. Exponent utilized four burners positioned under the span of the T-shaped battery to provide an even heat source to the entire battery pack, as shown in Figure 15 and Figure 16. The burners were placed six inches under the battery, as measured from the top of the nozzle tip to the bottom of the battery frame to allow for optimal flame development from the burners.

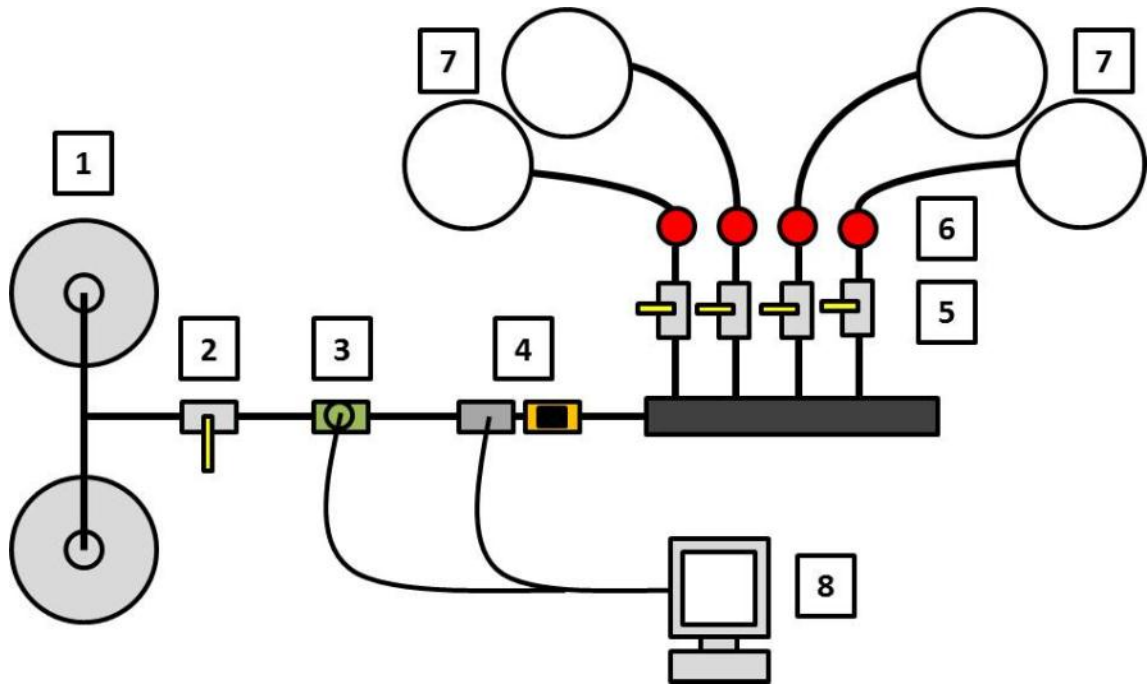

Figure 13 Layout of burner assembly

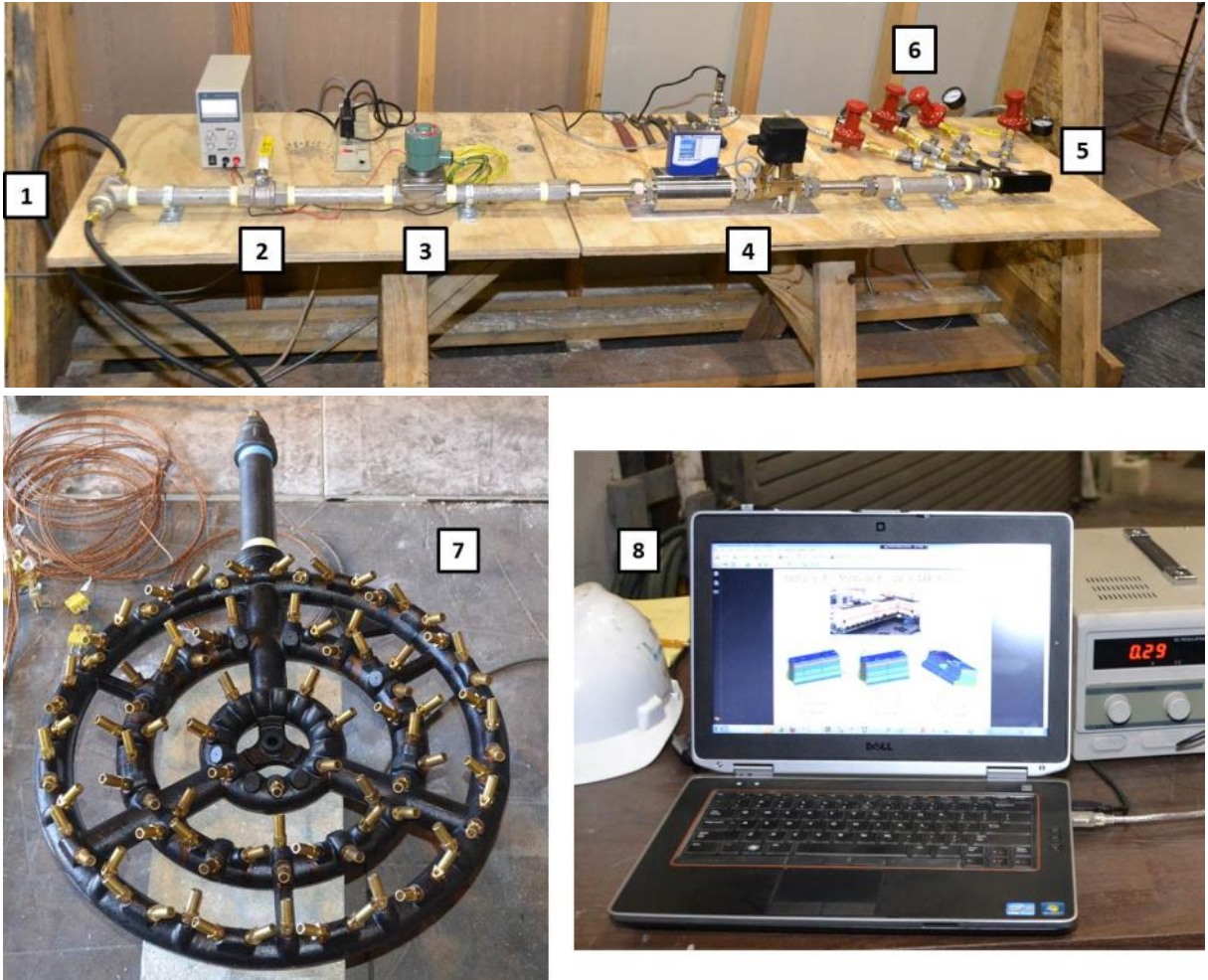

Figure 14 Burner assembly (top); single burner (bottom left); and DAQ (bottom right)



Figure 15 T-shaped burner arrangement comprised of four burners



Figure 16 Four burners positioned under Battery B



### **5.1.3 HRR Measurements**

The HRR was measured during the test by SwRI using oxygen consumption calorimetry. This requires the measurement of gas concentrations, namely oxygen (O<sub>2</sub>), carbon dioxide (CO<sub>2</sub>), and carbon monoxide (CO) in the exhaust duct and the volumetric flow of these gases. The products of combustion and entrained air were collected in a hood and extracted through a duct by an exhaust fan. A sample of the gas was drawn from the exhaust duct through a sample line by a pump and analyzed for O<sub>2</sub>, CO<sub>2</sub>, and CO concentrations. The gas temperature and differential pressure across a bi-directional probe were also measured to determine the mass flow rate of the exhaust gases. In addition, smoke production and smoke temperature measurements were taken throughout the duration of the test.

### **5.1.4 Products of Combustion Gas Sampling**

Product of combustion gas sampling was performed by SwRI using FTIR spectroscopy to analyze the byproducts of the battery fire. SwRI performed these measurements by positioning a smaller 10-foot by 10-foot steel truncated cone hood above the battery pack, as shown in Figure 17. The hood was positioned in this manner to concentrate the products of combustion for FTIR sampling. The top of the hood was open to allow the products to temporarily collect within the smaller hood but ultimately escape into the large hood setup for HRR measurements. A gas sampling tube with nine (9) 1-mm holes was located across the top of the smaller hood and was connected to a heated sample line. A pump drew the gases through the 1-mm holes and heated sample line and filled Tedlar grab bags at five minute intervals during testing.

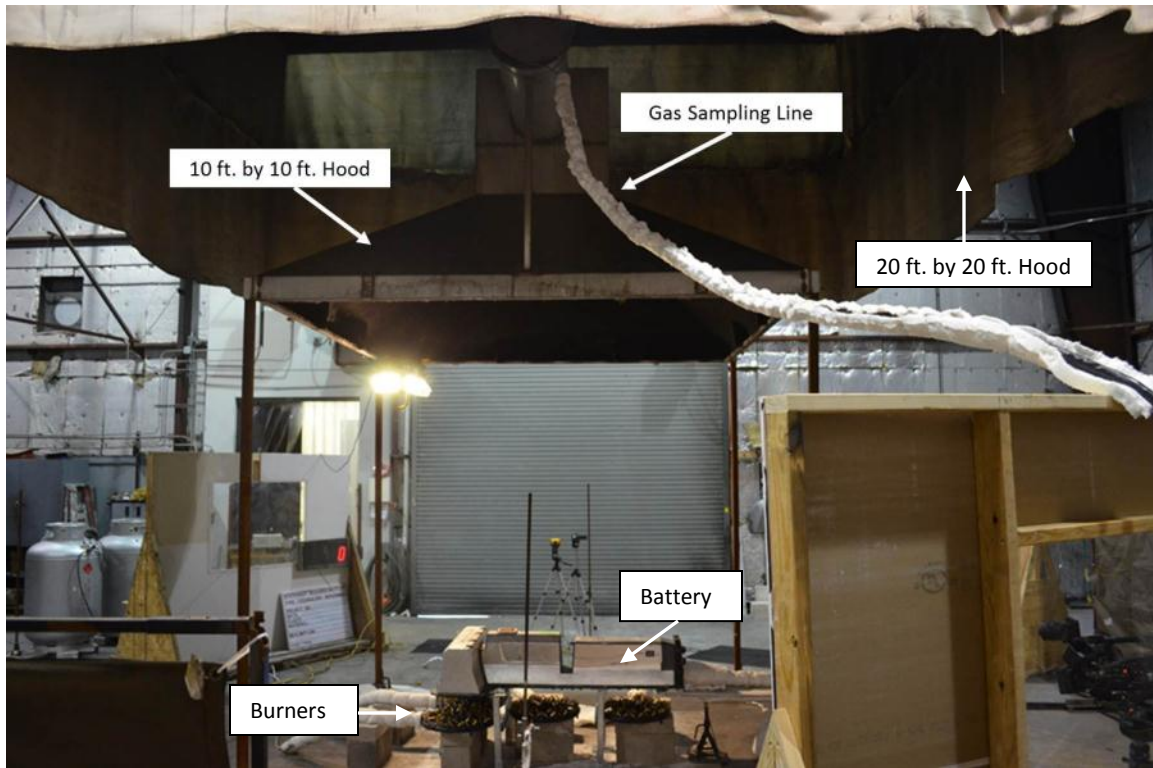

Figure 17 SwRI hood and test arrangement

### 5.1.5 Temperature and Heat Flux Measurements

The temperature and heat flux measurements were performed by SwRI using a total of twenty Type K thermocouples (TCs) and four Schmidt-Boelter HFGs, as shown in Figure 12 and Figure 18. The location and measurement description of the TCs and HFGs are listed in Table 2 and Table 3.



Table 2 Summary of TC Locations

<b>TC</b>	<b>Measurement</b>	<b>TC</b>	<b>Measurement</b>
1	Battery exterior	11	Battery exterior
2	Battery exterior	12	Battery exterior
3	Battery exterior	13	Battery interior
4	Battery exterior	14	Battery interior
5	Battery exterior	15	Battery interior
6	Battery exterior	16	Flame temperature
7	Battery exterior	17	Air temperature (5 ft)
8	Battery exterior	18	Air temperature (10 ft)
9	Battery exterior	19	Air temperature (5 ft)
10	Battery exterior	20	Air temperature (10 ft)

Table 3 Summary of HFG Locations

<b>Heat Flux Gauge</b>	<b>Measurement</b>	<b>Thermocouple</b>	<b>Measurement</b>
1	Heat Flux (5 ft)	3	Heat Flux (5 ft)
2	Heat Flux (10 ft)	4	Heat Flux (10 ft)

TCs 1 through 12 were fixed to the exterior surface of the battery using Omega Bond CC High Temperature Bonding cement. The cement was located over the TC bead and was allowed to dry for at least 24 hours prior to testing. TCs 13 through 15 were located inside three vents on the battery, as shown in Figure 19. The TCs were placed through the vent opening to measure the internal air temperature within the battery casing. The vent hole was covered with the appropriate self-adhesive covers provided by the manufacturer. TC 16 was positioned 1-inch under the bottom steel plate of the battery pack, just above the burners to measure the approximate flame temperature. TCs 17 through 20 were positioned around the perimeter of the battery pack to measure the air temperature at five and ten foot standoff distances. HFGs 1 through 4 were also positioned at the same five and ten foot standoff distances and were capable of measuring a radiant heat flux between 0 and 50 kW/m<sup>2</sup>.

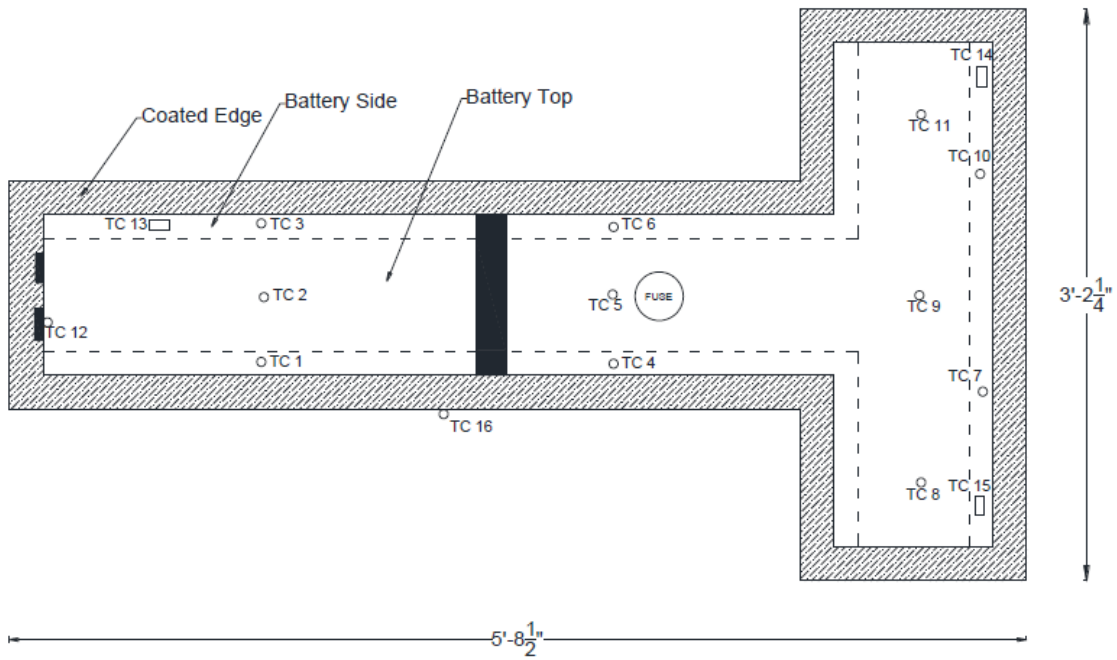

Figure 18 TC locations around Battery B during HRR testing (see Figure 12 for TC and HFG positions around the perimeter of the battery pack)

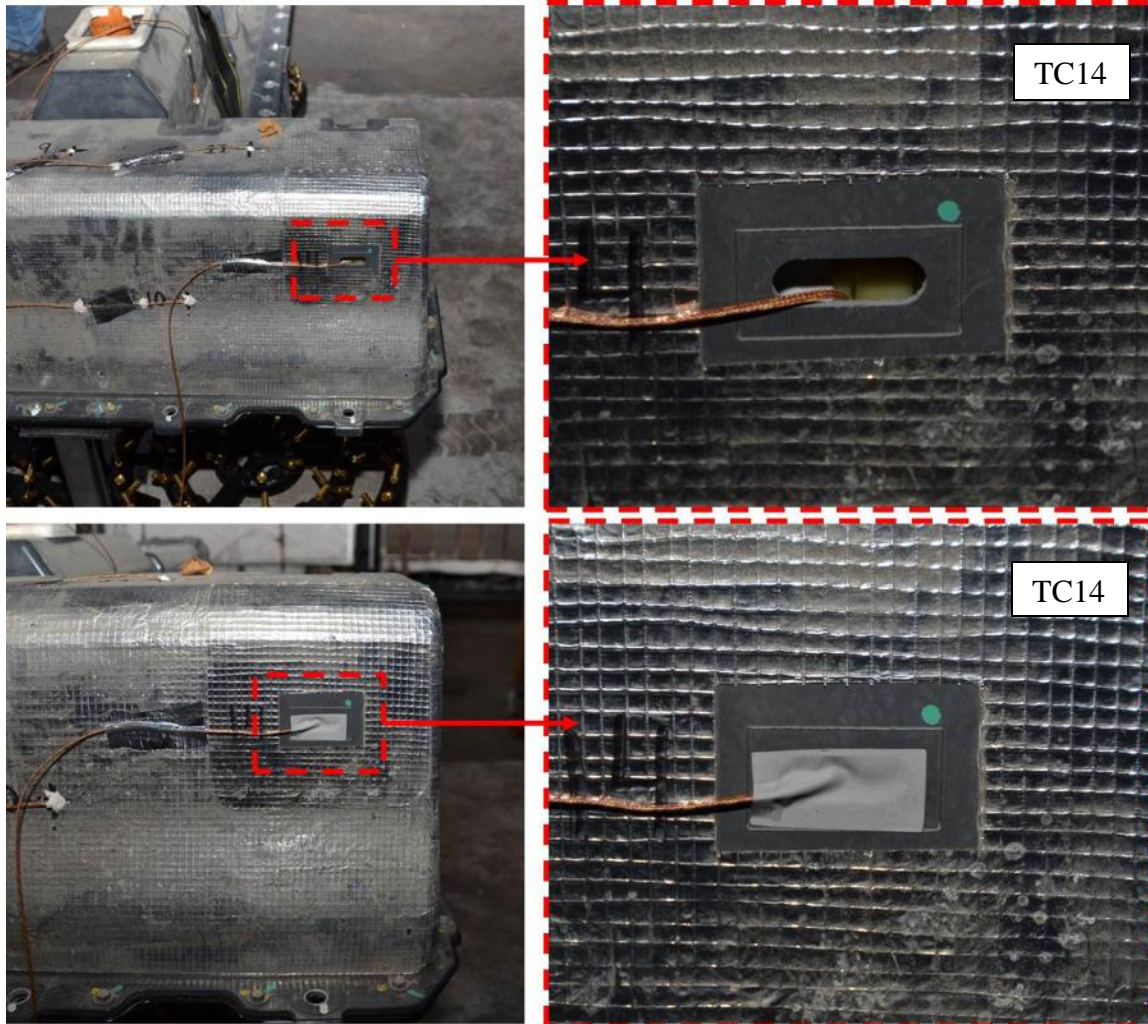

Figure 19 Installation of typical TCs inside Battery B

### 5.1.6 Internal Battery Sensor Measurements

During the fire test, Exponent collected internal battery temperatures and individual cell voltages from the battery's own sensors, including 96 cell voltages and nine temperature sensors as possible. To collect this data, Exponent communicated directly with the battery through its own CAN bus protocol utilizing a custom Lab VIEW software program. This allowed Exponent to retrieve internal battery temperatures and cell voltages as the battery was being exposed to an external heat source. The CAN bus protocol is a serial bus standard that allows automotive components to communicate with each other. The custom Lab VIEW code used the National Instruments (NI) XNET protocol in combination with the NI 9862 CAN bus module and a 7-port NI CAN breakout box, which allowed Exponent to send and receive individual data

frames to and from the battery. The NI 9862 is a single-port high-speed CAN bus module and the 7-port NI CAN breakout box provided a means to power the CAN port and to set the termination resistance. The NI 9862 bus module and CAN breakout box are shown in Figure 20. The NI 9862 was connected to the breakout box using an NI CAN high-speed cable. The breakout box was in turn connected to the battery using a custom interface cable provided by the manufacturer. In addition, the manufacturer provided the necessary binary codes to Exponent to use in its custom Lab VIEW program so that communication could occur. This cable connected directly to the battery, as shown in Figure 21. To protect these connection points and the cables, a calcium silicate board assembly was installed just below the connection points to shield the area from direct flame impingement by the burners below. In addition, Kaowool insulation ceramic fiber blankets were wrapped around these connection points and cables to insulate them from heat, as shown in Figure 22.

The custom Lab VIEW program was part of the same DAQ system that was used to control the burner assembly discussed previously in Section 5.1.2. The DAQ will be discussed in more detail in Section 5.1.7.



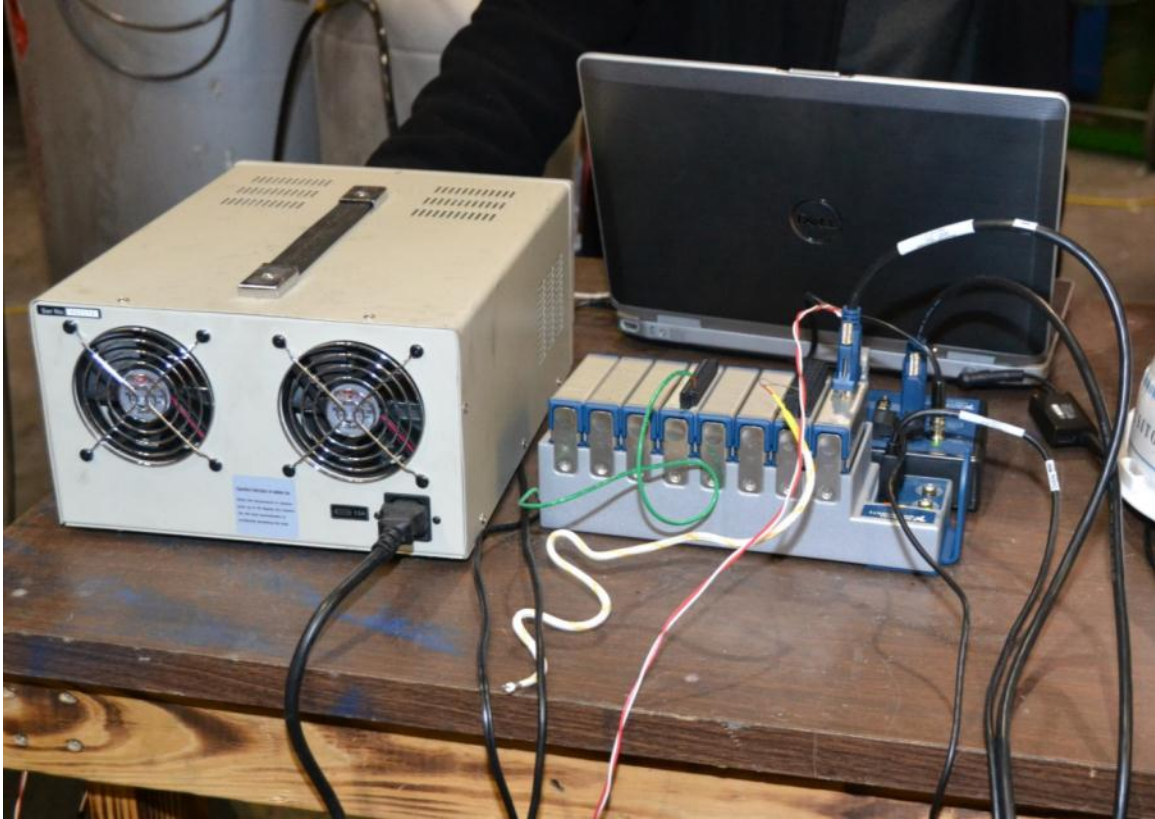

Figure 20 NI 9862 CAN bus module and 7-port NI CAN breakout box

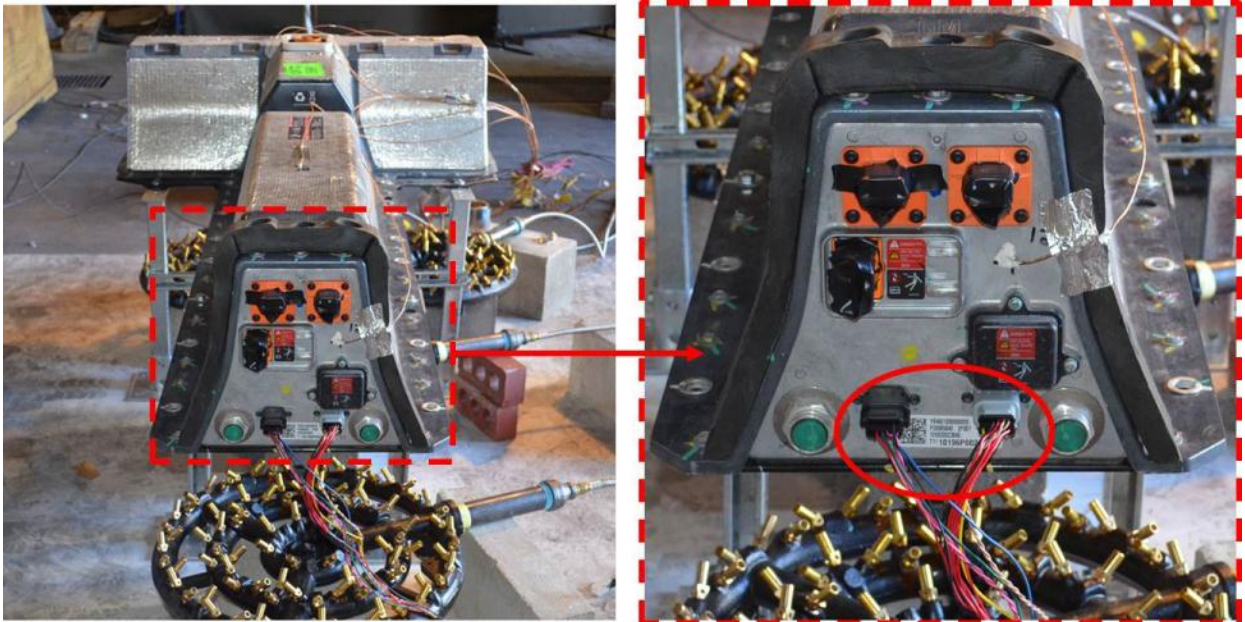

Figure 21 Location of the connection points to the internal battery sensors (circled right)

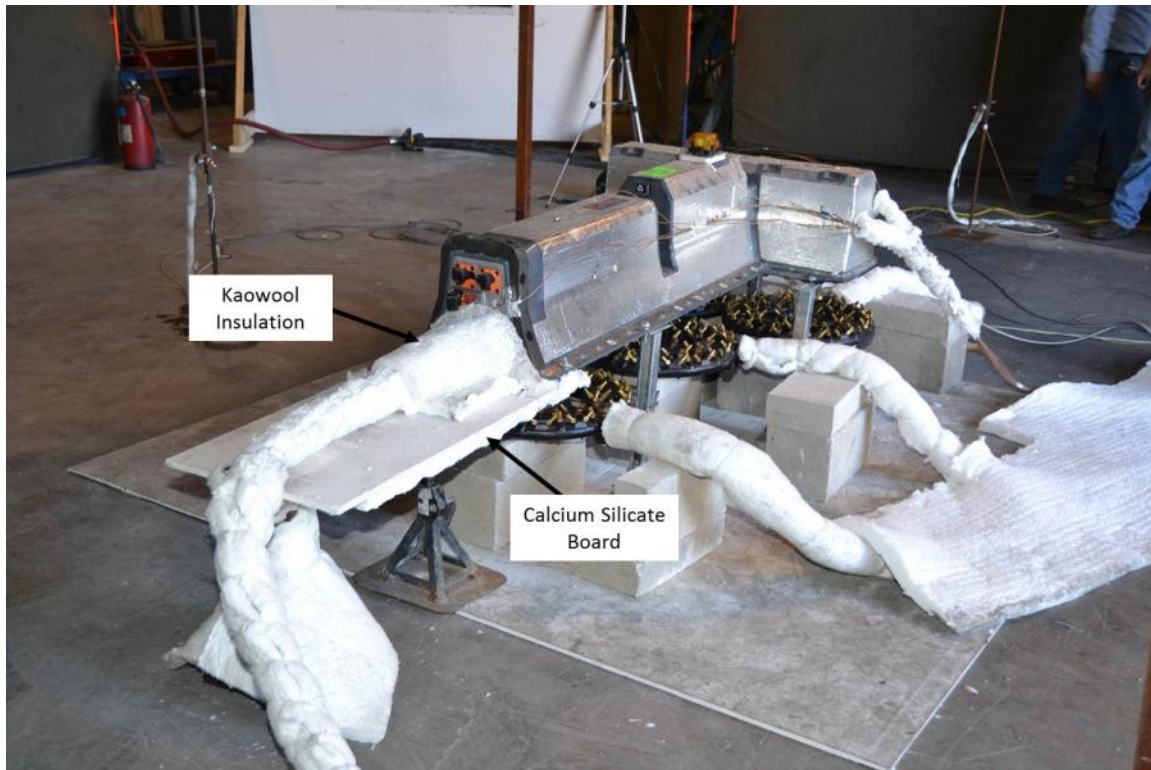

Figure 22 Protection scheme for the connection points and cables

### 5.1.7 DAQ System

The data acquisition was performed by a custom Lab VIEW code. The code performed three simultaneous tasks during the HRR testing:

- CAN bus communication with internal battery cell voltage and temperature sensors;
- Digital output to the relay module to control the burner; and
- Serial input and output to the mass flow meter.

These tasks were performed by a modular data acquisition system, a NI cDAQ 9178, which is an eight-slot USB-based data acquisition chassis. To communicate with the battery, the DAQ requested data at one-second intervals. However, communication with the battery through the CAN bus was asynchronous, meaning data is transmitted intermittently rather than in a steady stream. Communication with the battery consisted of broadcasting a request for a particular piece of information and then waiting for a response. Requests for all voltages and temperatures were made at a rate of one per second, however not all of the data would be received during that

same second due to the asynchronous nature of the CAN bus. To circumvent this issue, each data frame received from the battery included identification bytes and a timestamp, so the data that was received could be properly identified and synchronized.

To communicate with the burner controls, a  $\pm 60$  VDC, 750 mA NI 9485 8-channel switching relay module and a serial cable was connected to the cDAQ 9178 chassis. The relay module was used to switch the burners on and off during the test. The serial cable was used to communicate with the mass flow controller during the test.

The remainder of the data collected during the HRR tests, such as O<sub>2</sub>, CO<sub>2</sub>, and CO concentrations for oxygen calorimetry, TC, and HFG measurements performed by SwRI were also recorded at one-second intervals.

### **5.1.8 Thermal Imaging, Still Photography and High Definition Video**

Thermal imaging, still photography, and high definition video were also recorded during the HRR testing by SwRI and Exponent. The thermal imager is a Fluke TI32 infrared camera with a temperature measurement range up to 1112°F. Infrared images were captured at 1-minute intervals during the test and after test completion to monitor the battery post fire. Still photography was captured using a Nikon D3100 digital camera. Representative images of the test were captured as possible during the test. High definition video was captured using a Canon Vixia HFS10 high definition camcorder. Three camcorders were used during testing (one by SwRI and two by Exponent) to ensure all angles of the battery were captured. The positioning of the high definition camcorders and thermal imager during testing is shown in Figure 12.

## **5.2 Full-scale Fire Suppression Testing**

The full-scale suppression testing was performed at MFRI in College Park, Maryland.<sup>42</sup> The objective of the suppression testing was to evaluate the following when dealing with an EDV battery fire:

---

<sup>42</sup> MFRI is Maryland's comprehensive fire and emergency response training and education agency. MFRI plans, researches, develops, and delivers quality programs to enhance the ability of emergency services providers to protect life, the environment, and property.

- Tactics and procedures for first responders;
- PPE of first responders;
- Adequacy and amount of water as a sole suppression agent; and
- Procedures for overhaul and post-fire clean-up.

Six tests were conducted; three for Battery A and three for Battery B. For each battery type, two of the tests were performed with only the battery pack positioned inside the VFT as they would be positioned in the host vehicle and one test was performed with typical interior finishes/upholstery (i.e., car seats, carpeting, dashboard, etc.). The additional interior finishes were installed within the VFT to simulate a fuel load more typical of a vehicle fire. Data collected during this test included:

- Temperatures;
- Heat fluxes;
- Projectile observations;
- Suppression water sampling;
- Volume of suppression water flow;
- Nozzle voltage and current measurements;
- Chassis voltage and current measurements;
- Battery internal temperatures;
- Battery internal cell voltage measurements;
- Thermal imaging;
- Still photography;
- High definition video; and
- MFRI staff / firefighter observations.



MFRI was responsible for providing the facility for the fire testing, the gear and equipment required for suppression efforts, all PPE and SCBA required for the firefighters, as well as the personnel to perform the fire suppression activities. Exponent was responsible for providing and controlling the external burner assembly used to ignite the battery pack and for providing all other instrumentation relating to data collection, still photography, and video recording.

### **5.2.1 VFT and Battery Positioning**

In lieu of procuring fully intact production vehicles for the full-scale suppression tests due to the extreme costs, Exponent, in conjunction with an outside contractor, Tactical Incident Systems<sup>43</sup>, designed and manufactured a VFT that could be outfitted with the two different battery assemblies. This allowed for multiple tests of different battery sizes, dimensions, and installation locations all while using the same VFT.

The VFT was constructed to resemble a modern EDV both in size and design, as shown in Figure 23 and Figure 24. It stands approximately 57 inches tall, 70 inches wide, and 15 feet long. The VFT was designed to open in the back, similar to a hatchback, to allow for the installation of the batteries as well as to facilitate firefighter access. The batteries were placed on top of a ¼-inch steel plate simulating the floor pan of the vehicle. The floor pan had two holes cut out to allow the burners, positioned below the VFT, direct access to the bottom of the battery assemblies, as shown as the shaded areas in Figure 23. Each of the battery assemblies weighed over 400 pounds, as such, two carriages, one for each battery type, were constructed for the battery assemblies to sit inside the VFT. The carriages were placed inside the VFT and rolled into position, either in the cargo compartment for Battery A or the middle of the VFT for Battery B, as shown in Figure 25 through Figure 27. The carriages rolled on wheels in two (2) 3-inch wide welded channels installed on top of the steel floor pan. The passenger compartment was framed of 2-inch by 2-inch by ¼-inch welded steel tube. The exterior of the VFT was formed of ¼-inch steel plates and was painted black. The frame was supported by four “peg legs” hidden behind fixed steel tire assemblies. The fixed tires were not operational and were for aesthetic purposes only. Two (2) 8-inch by 4-inch by ¼-inch steel tubes were installed

---

<sup>43</sup> Tactical Incident Systems, 9130 Flint Overland Park, Kansas 66214





Figure 24 VFT: Side profile (top); rear profile with hatchback open (bottom left); and front profile with hood open (bottom right)

1205174.000 F0F0 0613 RTL3





Figure 25 Carriage installed inside the VFT positioned above the four burners located in the rear test position



Figure 26 Battery A positioned on the carriage above the burners and inside the VFT



Figure 27 Battery B positioned on the carriage above the burners inside the VFT; burners located in the center test position

The VFT was placed on a concrete burn pad at MFRI, as shown in Figure 28. The burners slid under the VFT and into position depending on the battery type and had direct access to the bottom of the batteries through the holes cut out in the VFT floor pan. For Battery A, the four burners were centered six inches under the rectangular battery, as shown in Figure 25 and Figure 26. For the first two tests, Tests A1 and A2, the battery was installed alone within the VFT, as shown previously in Figure 26. For test A3, typical interior finishes/upholstery, including car seats, a dashboard, and a carpet layer above the battery (used to separate the battery from the cargo compartment) were also installed within the VFT, as shown in Figure 29 through Figure 33. The car interiors were procured from vehicles that were of a similar size as the VFT. These additional vehicle interior finishes were installed to better simulate the fuel load of a typical vehicle.



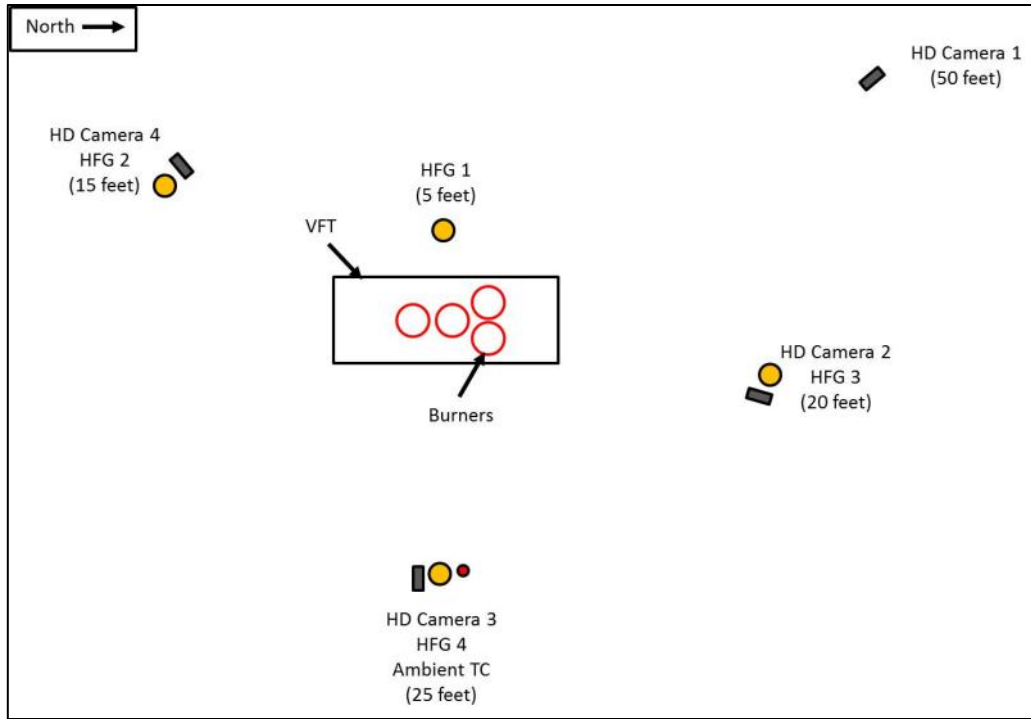

Figure 28 Layout and arrangement of the suppression testing perimeter instrumentation



Figure 29 Overall view of the VFT with interior finishes for Test A3



Figure 30 Dashboard and front seats installed inside the VFT for Test A3



Figure 31 Front seats installed inside the VFT for Test A3



Figure 32 Back seats installed inside the VFT for Test A3



Figure 33 Carpet installed on top of the battery for Test A3



For Battery B, the four burners were positioned under the span of the T-shaped battery to provide a uniform heat source to the entire battery pack, as described in Section 5.1.2 for the HRR test. Inside its production vehicle, a steel floor pan is positioned on top of the battery, separating it from the passenger compartment. As such, the vehicle manufacturer that donated Battery B also donated a steel floor pan from an actual vehicle to be placed above the battery during testing. This configuration provided a more realistic vehicle fire scenario, as shown in Figure 34 and Figure 35. For the first two tests, Tests B1 and B2, the battery and the steel floor pan were installed within the VFT. For Test B3, typical interior finishes/upholstery, including car seats, a dashboard, and carpeting were added to the VFT along with the battery and steel floor pan, as shown in Figure 36 through Figure 40. The car interiors were procured from vehicles of a similar size to the VFT. These additional vehicle interior finishes were installed to better simulate the typical fuel load expected in a vehicle fire.



Figure 34 View of Battery B inside the VFT without the floor pan (top) and with the floor pan (bottom); the blue tank at the rear of the battery is the empty gasoline tank for the production vehicle, which blocks direct access to the rear of the battery

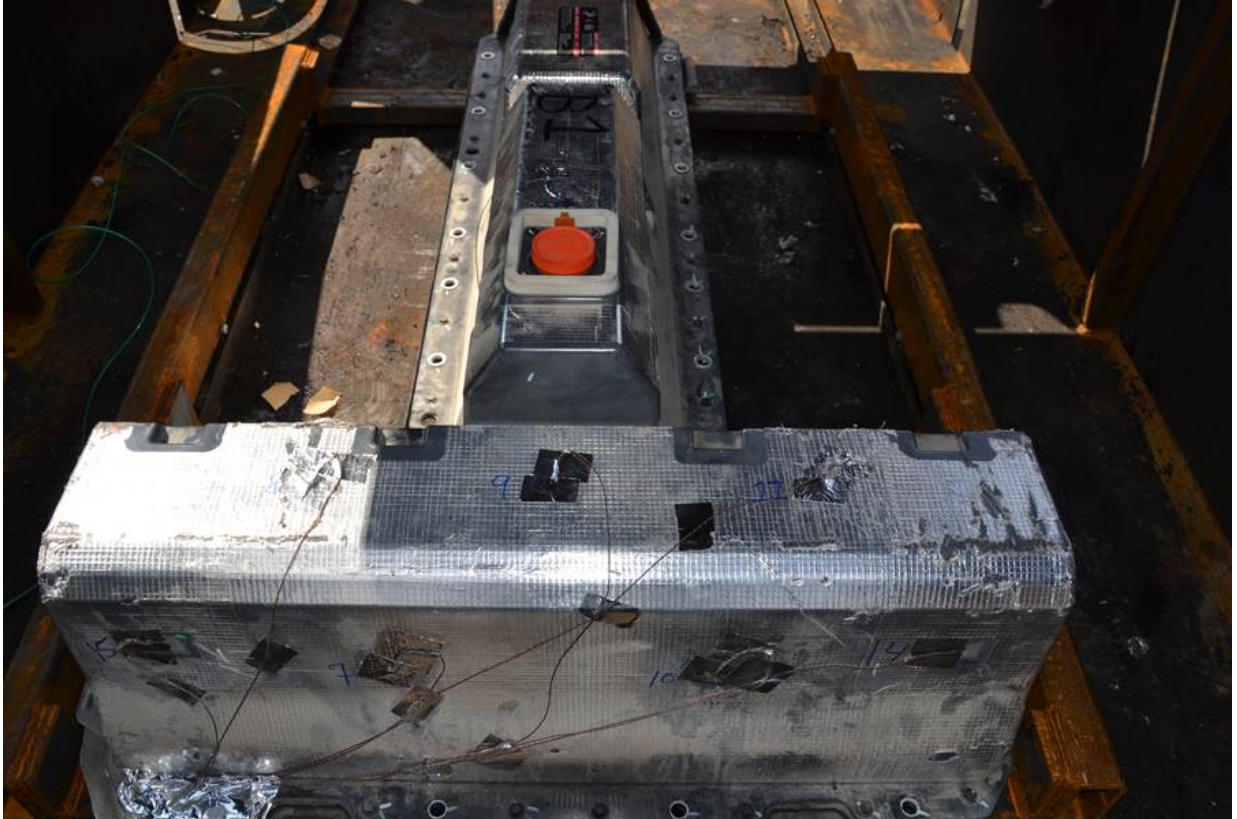

Figure 35 Top view of Battery B inside the VFT without the floor pan (top) and with the floor pan (bottom); the yellow fuse in the middle of the red floor pan is the only hole within the pan that allows for access to the battery





Figure 36 Overall view of the VFT with interior finishes for Test B3



Figure 37 Dashboard, front seats, and carpet installed inside the VFT for Test B3



Figure 38 Front seats and carpet installed inside the VFT for Test B3



Figure 39 Back seats installed inside the VFT for Test B3





Figure 40 Back seats and carpet installed inside the VFT for Test B3

### 5.2.2 Burner Description

The components, design, and function of the burner assembly utilized during the full-scale fire suppression testing were the same as those used during the HRR test, as described previously in Section 5.1.2. The only difference between the two setups, Battery A and Battery B, was the positioning of the burners under the VFT, as described in the previous section.

### 5.2.3 Electrical Measurements during Fire Suppression

One of the objectives of this test series was to evaluate the potential electric shock hazards associated with fighting EDV fires. Literature was reviewed on the subject of electric shocks and the physiological response to touch potentials, as well as the impedance of the human body.<sup>44,45,46,47</sup> In addition, literature was reviewed to investigate methodologies of fire

---

<sup>44</sup> Backstrom, R. and Dini, D.A., “Firefighter Safety and Photovoltaic Installations Research Project” November, 29, 2011.

<sup>45</sup> NFPA 15, 2007 edition, Chapter 6.

suppression of electrical fires<sup>44,48,49,50,51,52,53</sup>, as well as literature discussing previously-used testing methodologies for measuring voltage and current through a water stream and the effect of PPE.<sup>44,48,54</sup> These previous studies provided guidance as to how to best measure and collect electrical data during the test to (1) protect the firefighters suppressing the fires and (2) provide useful data to the firefighting community in regards to potential electrical hazards during suppression of an EDV fire.

Electrical measurements were recorded to investigate the possibility of electric shock by a firefighter while suppressing an EDV fire. While both voltage and current measurements were recorded, the parameter important for characterizing the potential shock hazard is current. While simultaneous voltage measurements can provide an indication as to the presence of a shock hazard, the effects of voltage on different individuals can vary substantially. Conversely, the current magnitude can be directly related to physiological effects ranging from a slight tingling sensation to cardiac arrest and probable death.<sup>55</sup>

Another important parameter is the conductivity of water used for the suppression of the fire. Electrical conductivity is a measure of the ability of a material to conduct (or allow the flow) of electricity and is measured in units of Siemens per meter (S/m). Good conductors, such as copper, have a very high conductivity ( $5.96 \times 10^7$  S/m), whereas poor conductors (or insulators),

---

<sup>46</sup> OSHA Construction eTool, “How Electrical current Affects the Human Body”,  
[http://www.osha.gov/SLTC/etools/construction/electrical\\_incidents/eleccurrent.html](http://www.osha.gov/SLTC/etools/construction/electrical_incidents/eleccurrent.html)

<sup>47</sup> Olsen, G. R., Schneider, J.B., Tell, R. A., “Radio Frequency Burns in the Power System Workplace” IEEE Transactions on Power Delivery, Vol. 26, No. 1, January, 2011.

<sup>48</sup> Bolander, G.G., Jughes, J. T., Toomey, T. A., Carhart, H.W., and J.T. Leonard. “Use of Seawater for Fighting Electrical Fires” Navy Technology Center for Safety and Survivability, Chemistry Division. May 25, 1989.

<sup>49</sup> “Electrical Conductivity of Extinguishing Agents”, Factory Mutual Handbook of Industrial Loss Protection,

<sup>50</sup> Thorns, J., “Feuerwehreinsatz an Hochvoltfahrzeugen.: Aufbau, Funktion und Einsatzhinweise” BrandSchutz, Zeitschrift fuer das gesamte Fuerwehrwesen, fuer Rettungsdienst und Umweltschutz. (English translation: Firefighting on High Voltage Vehicles: Structure, Function, and Application notes), March 2011

<sup>51</sup> Electric Vehicle Safety Training Online Blog, 08/14/2012

<sup>52</sup> Firehouse World, online firefighter blog, <http://www.firehouse.com/forums/t20745/>

<sup>53</sup> conEdison 2010 Sustainability Report downloaded from: <http://www.conedison.com/ehs/2010annualreport/print-template.asp>

<sup>54</sup> Sprague, C.S. and C.F. Harding. “Electrical Conductivity of Fire Streams” Research series no. 53. Engineering Experiment Station, Purdue University Lafayette, Indiana, January 1936

<sup>55</sup> OSHA [http://www.osha.gov/SLTC/etools/construction/electrical\\_incidents/eleccurrent.html](http://www.osha.gov/SLTC/etools/construction/electrical_incidents/eleccurrent.html).

such as glass, have a very low conductivity (approximately  $1 \times 10^{-11}$  S/m or less). The conductivity of water is typically much lower than good conductors and is, therefore, often measured in units of microSiemens per centimeter ( $\mu\text{S/cm}$ ). The conductivity of water is, however, highly dependent on the amount of other material (minerals, salts, etc.) dissolved in the water. For example, deionized water is a poor conductor ( $0.055 \mu\text{S/cm}$ ), while seawater (with a high salt content) is a much better conductor ( $58,000 \mu\text{S/cm}$ ). In order for a firefighter to experience an electrical shock during fire suppression efforts, the firefighter must either make physical contact with something held at an elevated voltage potential (thereby providing a path for the electricity to ground) or the electricity must pass through the water stream back to the firefighter in order to complete the circuit. The conductivity (or ability of the water to conduct electricity) will, therefore, play a role in determining the potential shock hazard. A sample of water was collected from the suppression water source used for the tests and its conductivity was tested by Microbac Laboratories, Inc.<sup>56</sup> The conductivity of the water used during the suppression tests was found to be  $190 \mu\text{S/cm}$ , which is a very low conductivity. The full Microbac Laboratories report is provided in Appendix C.

Previous tests<sup>57</sup> have characterized the shock hazard of alternating current (AC) electricity at a variety of voltage levels, nozzle patterns, and distances, as well as water conductivities. In these tests, a metal screen or plate was intentionally energized to a specified voltage and then the voltage and/or current level was measured as a function of distance from the energized source. The effect of water conductivity was also assessed in these tests, with water ranging from well water ( $185 \mu\text{S/cm}$ ) to seawater ( $58,000 \mu\text{S/cm}$ ). Finally, these previous tests performed measurements where the nozzle was connected through a short circuit to ground (no additional resistance) or, optionally, through a 500 Ohm resistor to simulate the resistance of an average person to the flow of electricity (under wet conditions).

Following a similar methodology to previous studies, the electrical measurements performed in Exponent's full-scale fire suppression tests were conducted by measuring both the voltage and current at the nozzle. In addition, the voltage and current at the body of the chassis in which the

---

<sup>56</sup> Microbac Laboratories, Inc. 2101 Van Deman Street . Baltimore, MD 21224

<sup>57</sup> Sprague and Harding, 1936; Bolander 1989



battery was placed were also measured. For the electrical measurements at the nozzle, 14 AWG stranded copper wire was securely soldered to a hose clamp and affixed to the nozzle's exterior housing, as shown in Figure 41. Continuity tests confirmed that the front of the nozzle from which water was expelled was electrically connected to the discharge portion of the nozzle. The wire was then routed back to the DAQ system utilized to collect the voltage and current measurements, as shown in Figure 42. Similarly, at the chassis, a separate 14 AWG stranded copper wire was securely connected to the body of the chassis and run along the ground to the DAQ system, where it was connected to the measurement circuit shown in Figure 42. Inside the chassis, additional metallic components, such as the sliding chassis and the VFT body components were also connected using a 14 AWG stranded copper wire to the same measurement wire such that all conductive items, including the sliding chassis and the VFT body components, were electrically connected. Due to the high temperatures expected inside the VFT, the internal wires were protected using aluminum foil and Kaowool. Though in most tests the wire insulation nearest the most intense portion of the fire was found to be degraded in post-test assessment, continuity after each test was confirmed to verify all conducting objects in the chassis remained electrically connected throughout the test.



Figure 41 14 AWG stranded copper wire soldered to a hose clamp and affixed to the nozzle's exterior housing

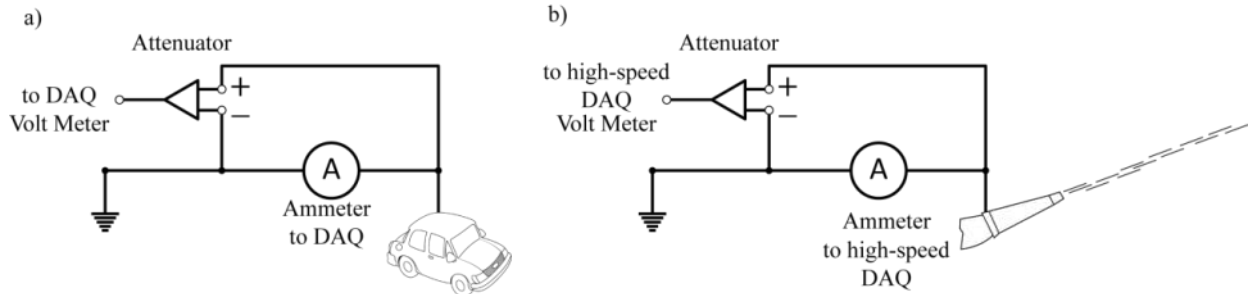

Figure 42 Simplified circuit diagram for the electrical measurements

Due to the likely transient nature of the electrical connection from the EDV battery to the nozzle through the water stream, a high-sampling-rate of 2 kilohertz (kHz) was performed to identify any brief electrical connection of the EDV battery voltage to the nozzle. This allowed for the detection of any electrical activity at the nozzle such that the hazard could be relayed to the firefighters as quickly as possible and data could be collected and subsequently analyzed regarding the potential electrical hazards involved with suppressing an EDV fire. For the chassis measurements, the transitory nature of voltage/current flow was not expected; therefore, measurements were recorded at one-second intervals, or 1 Hertz (Hz). These measurements were collected for as long as fire suppression activities were being performed.

In both measurement cases, the maximum voltage level of the battery was approximately 400 VDC, while the maximum input voltage of the DAQ was limited to  $\pm 10$  V. In order to ensure that the full voltage range was covered, a voltage attenuator was incorporated into the voltage measurement circuit, as shown in Figure 42. In addition, due to the long wires necessary in connecting the nozzle and chassis to the DAQ system, external sources of noise were present. The most prevalent noise was from power lines at 60 Hz and their harmonics. The 1 Hz sampling used for the chassis measurements was too low to be affected by the power-line noise, however, the nozzle measurements sampled at 2 kHz were significantly affected by not only the 60 Hz fundamental frequency of the power-line, but also the first 15 harmonics (120 Hz, 180 Hz,... 960 Hz). Post-test analysis confirmed that the noise from these power-line sources was seen in the voltage measurements. As such, a comb-filter comprising each of these frequencies was applied to the recorded data to mitigate these effects.

Current measurements for both the nozzle and chassis were performed through the use of Hall-effect probes. The magnitude of current conducted to ground through either the nozzle or from the chassis were expected to be relatively low, therefore a relatively high-gain setting (100 mV/A) was selected for both probes. While this selection is more likely to detect relatively low current levels on the respective wires, the higher gain also contributes to relatively higher noise levels, which were addressed by post-test filtering and processing of the data, including background noise subtraction and averaging.

The four measurements described here, the high-speed 2 kHz sampling rate current and voltage measurements of the nozzle and the 1 Hz sampling measurements of the chassis current and voltage were performed using the DAQ described in Section 5.2.7.

#### **5.2.4 Water Sampling**

Contaminated water runoff created by suppression of an EDV fire is an environmental concern, as well as a concern to first responders in regards to their PPE. To evaluate this potential hazard, Exponent collected water samples after each test to analyze what, if any, potentially harmful byproducts may be present in the water. Approximately one pint of water was collected in a sealed glass jar after each test. The water was collected off the ground approximately two feet in front of the VFT after suppression efforts had ceased by one of the firefighters, as shown in Figure 43. This collection method was utilized, as opposed to collecting water from directly underneath the battery through a collection pan or trough, to better sample from a location that first responders would be performing activities, possibly standing in the water, during and immediately after suppression activities. The chemical analysis of the water samples was performed by Analyze, Inc.<sup>58</sup>

Once received by Analyze, Inc., the test samples were filtered of any particulates (debris) prior to analysis. Each sample was analyzed for pH using a Fisher Scientific Accumet Excel XL15 pH meter and screened for cations and anions using a Dionex ICS-2000 Ion Chromatograph. In addition, elemental analysis was performed to survey the amount of organic and inorganic

---

<sup>58</sup> Analyze, Inc. 318 South Bracken Lane, Chandler, Arizona, 85224.

carbon present in the samples. The full water sampling report from Analyze, Inc. detailing the measurement techniques is provided in Appendix D.



Figure 43 Water sample collection during test A1 just in front of the VFT

## 5.2.5 Temperature and Heat Flux Measurements

The temperature and heat flux measurements were performed using sixteen 0.10-inch diameter Type K TCs and four Schmidt-Boelter HFGs, as shown in Figure 28. The location and measurement description of the TCs and HFGs are provided in Table 4 and Table 5. These measurements were collected for at least one hour after testing or until external battery temperatures had dropped to near ambient levels, whichever was first.

During Battery A tests, TCs 1 through 12 were fixed to the exterior surface of the batteries using Omega Bond CC High Temperature Bonding cement, as shown in Figure 44. The cement was located over the TC bead and allowed to dry prior to testing. An ambient TC was placed 25 feet east of the VFT, as shown in Figure 28.

During Battery B tests, TCs 1 through 15 were installed in the same locations around the exterior of the battery and within the interior of the battery through the vent holes, as described in Section 5.1.5 and as shown in Figure 45.

During all six of the Battery A and B tests, HFGs 1 through 4 were positioned at 5, 15, 20, and 25 foot standoff distances from the VFT. The HFGs were capable of measuring a radiant heat flux between 0 and 50 kW/m<sup>2</sup>.

Table 4 Summary of TC Locations

<b>Thermocouple</b>	<b>Measurement</b>	<b>Thermocouple</b>	<b>Measurement</b>
1	Battery exterior	9	Battery exterior
2	Battery exterior	10	Battery exterior
3	Battery exterior	11	Battery exterior
4	Battery exterior	12	Battery exterior
5	Battery exterior	13	Battery interior (B only)
6	Battery exterior	14	Battery interior (B only)
7	Battery exterior	15	Battery interior (B only)
8	Battery exterior	16	Ambient temperature

Table 5 Summary of HFG Locations

<b>Heat Flux Gauge</b>	<b>Measurement</b>	<b>Thermocouple</b>	<b>Measurement</b>
1	Heat Flux (5 ft)	3	Heat Flux (20 ft)
2	Heat Flux (15 ft)	4	Heat Flux (25 ft)



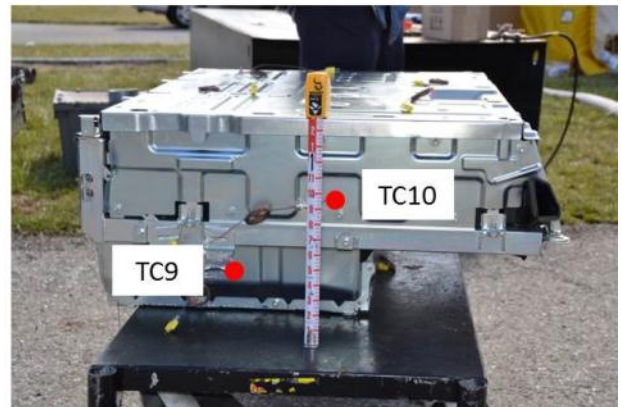
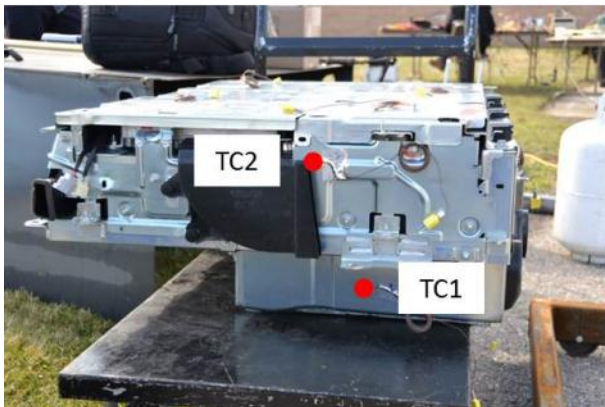

Figure 44 TC locations (red circles) on battery exterior for Battery A tests

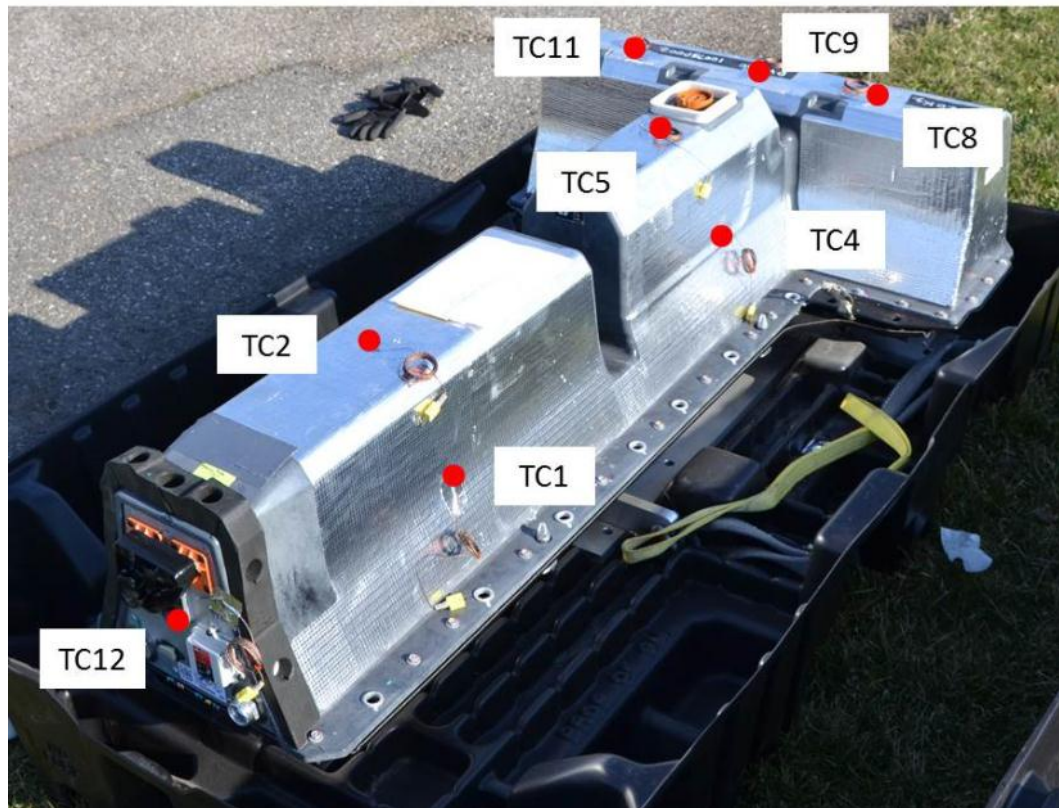
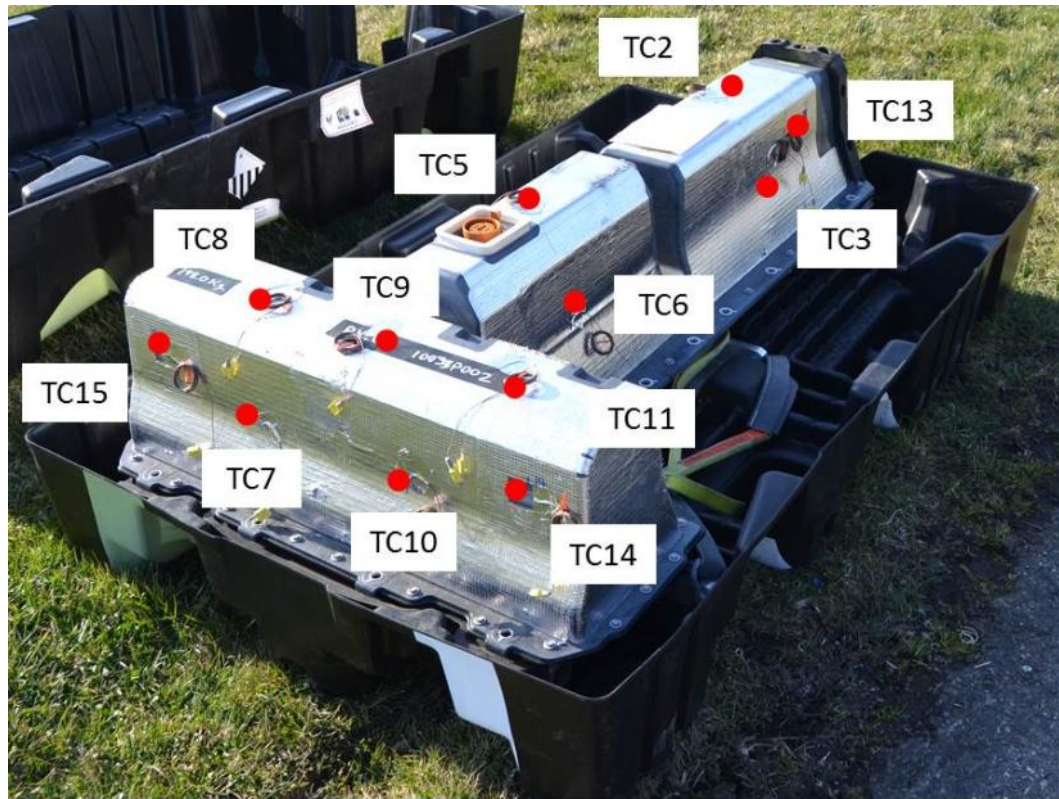

Figure 45 TC locations (red circles) on battery exterior/interior for Battery B tests

## 5.2.6 Internal Battery Sensor Measurements

During the Battery B tests, Exponent collected internal battery temperatures and individual cell voltages from the battery's own sensors. Exponent was not provided with the necessary supporting information to communicate with the A series batteries. These measurements were collected for as long as the connection between the battery and the DAQ system would allow (i.e., that is until fire exposure conditions compromised the communication paths). To collect this data, Exponent communicated directly with the battery using the same software programs, cables, equipment, sensors, and connection points to the battery described in Section 5.1.6. Prior to the suppression tests however, the battery was installed within the VFT, which required a slightly modified protection scheme for the battery's connection points. To protect these connection points, a modified calcium silicate board structure was erected around the front end of the battery once it was positioned within the VFT, as shown in Figure 46 and Figure 47. This structure shielded the connection area from direct flame impingement by the burners below, as well as any flames licking around the bottom edge and sides of the battery. In addition, Kaowool was inserted into the structure to insulate the connection points further and wrapped around the cables running to the battery from the DAQ system.







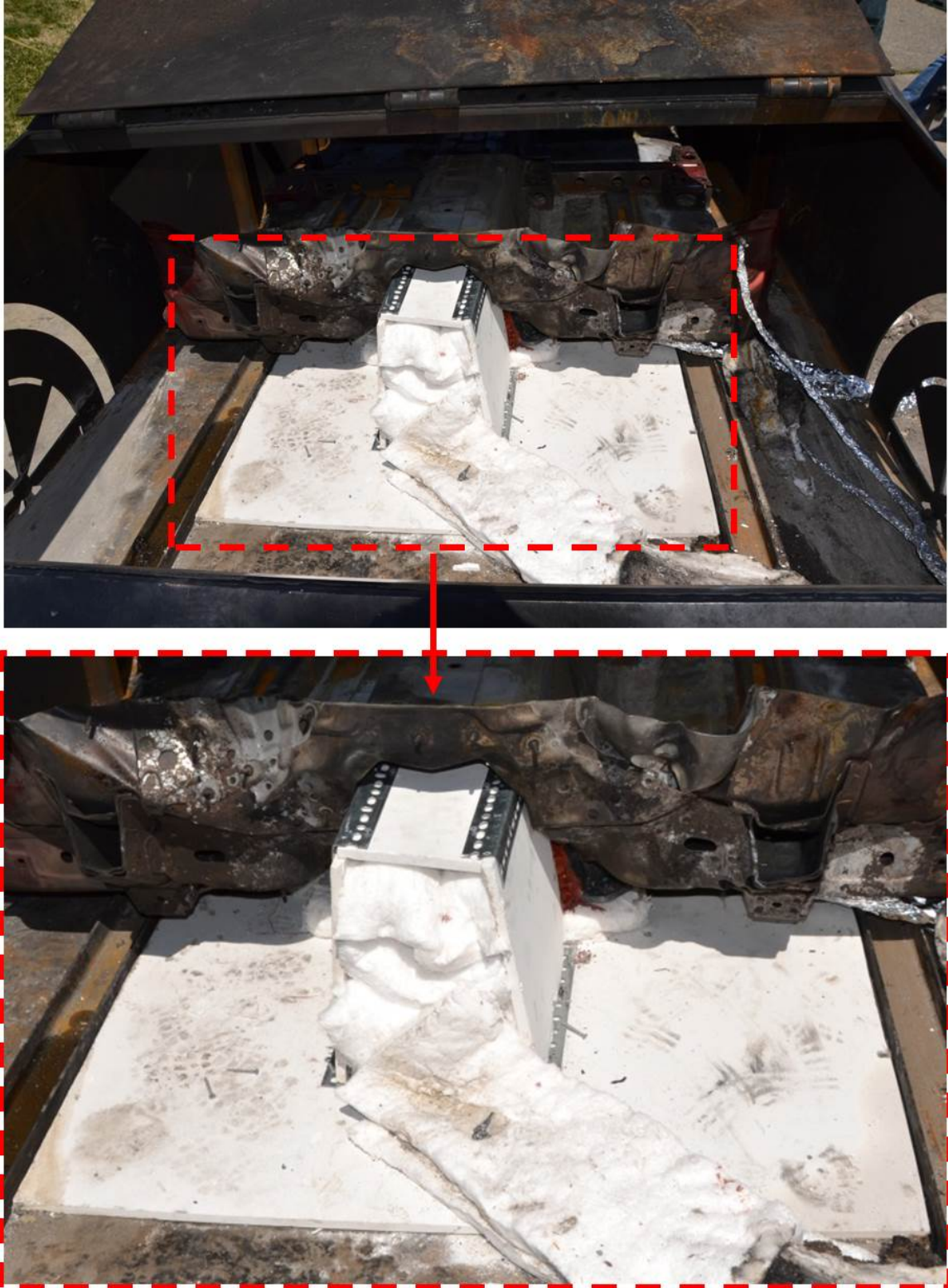

Figure 47 Protection scheme for the connection points and cables running to Battery B

## 5.2.7 DAQ System

Data acquisition was performed by a custom Lab VIEW code. The code performed five simultaneous tasks during the suppression testing:

- Analog input at a rate of 1 Hz for the TCs, HFGs, and chassis electrical measurements;
- Analog input at a rate of 2 kHz for the nozzle electrical measurements;
- CAN bus communication with individual internal battery cell voltage and temperature sensors;
- Digital output to the relay module to control the burner; and
- Serial input and output to the mass flow controller.

The temperature measurements consisted of up to sixteen Type K TCs and four calibrated Schmidt-Boelter HFGs. The TCs were monitored by an NI 9213 16-channel, 24-bit resolution TC module with built-in cold-junction compensation, as shown in Figure 48. The HFGs were monitored by an NI 9207 8-channel current/8-channel voltage module and a 24-bit resolution module with 50/60 Hz noise rejection. The TCs and HFGs were monitored continuously at a sampling rate of 1 Hz, or once per second.

The electrical measurements were performed at two different sampling rates by two data acquisition modules. The chassis voltage and current were monitored at a sampling rate of 1 Hz by the NI 9213 module described above. The nozzle voltage and current were continuously sampled at a rate of 2000 Hz by an NI 9239 module, a high-speed 4-channel analog input module with 24 bits of resolution, channel-to-channel isolation and anti-aliasing circuitry.

CAN bus communication and burner control were performed using the same software programs, cables, equipment, and connection points to the battery described in Section 5.1.7.

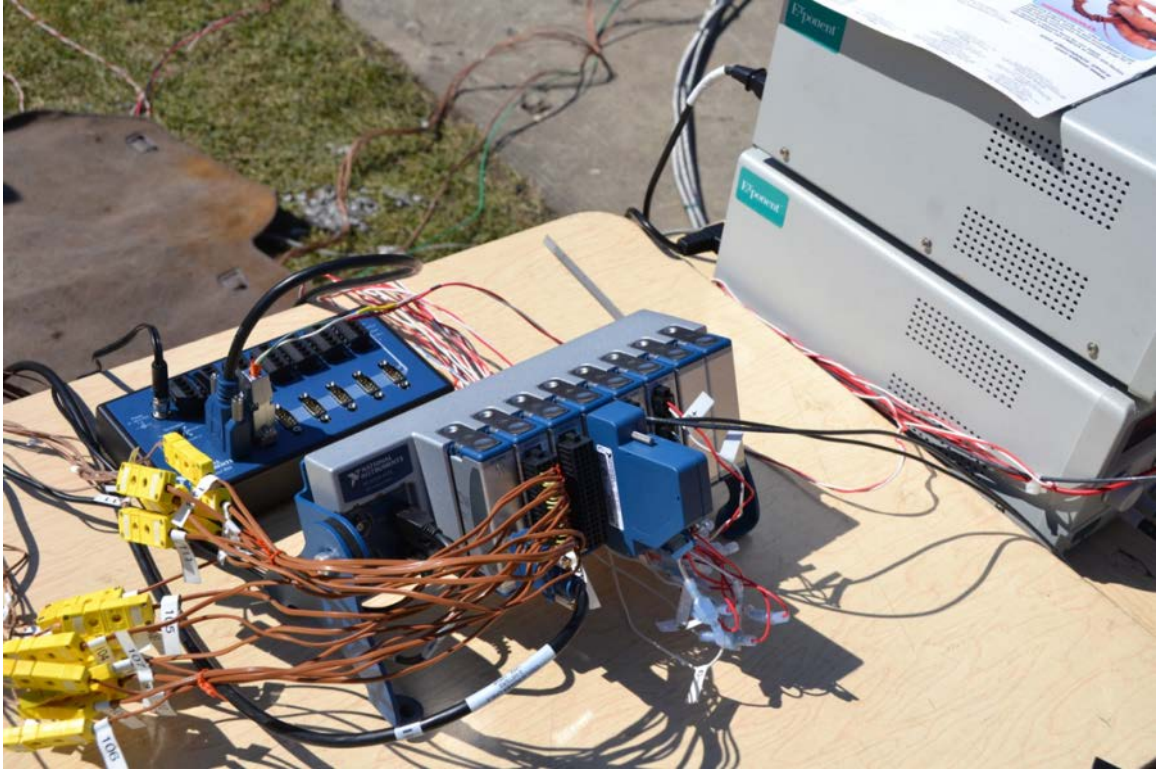

Figure 48 NI 9213 TC module and NI 9207 voltage module (for HFGs) plugged into the NI cDAQ 9178 data acquisition chassis

### **5.2.8 Thermal Imaging, Still Photography and High Definition Video**

Still photography and high definition video was recorded during the suppression testing by Exponent using the same cameras as described in Section 5.1.8. Images of the tests were captured as the situation warranted and/or important events occurred. Four high definition camcorders were used during testing to ensure all angles of the VFT and battery were recorded. The positioning of the high definition camcorders during testing is shown in Figure 28.

Due to the position of the batteries within the VFT, it was not possible to take thermal images that could provide meaningful data during the suppression tests given that direct access was obstructed by the VFT or floor pan components. However, thermal images were recorded after test completion to supplement the TCs in monitoring the battery post fire. The thermal imager used during the suppression tests was the same as described in Section 5.1.8.

## 5.2.9 Suppression Activities

Suppression activities were handled by MFRI. No guidance was given to the firefighters regarding what they could and could not do tactically to suppress the fires. They were instructed to fight the fire as they would normally approach a vehicle fire with an offensive attack. Any tactics or modifications to those tactics during the fire tests were at the sole discretion of the MFRI staff and based on their many years of firefighting and training experience. The suppression team was restricted from using any forcible tools to access the VFT or the battery for safety reasons.

However, due to the setup of the tests, there were two limitations regarding how MFRI could attack the fires: (1) they were not able to fight the fire from the east side of the VFT, as the instrumentation wires and cables in that area posed a tripping hazard and (2) they were not able to fight the fire from underneath the VFT (i.e. shooting water up to the undercarriage of the batteries) due to the presence of the four propane burners.

These two limitations did not greatly affect MFRI's tactics, as the VFT was designed to provide ample access to the interior of the VFT. Each VFT window was open to air, mimicking a more involved vehicle fire, where all of the windows would be broken prior to fire department arrival or by first responders once on scene, as shown in Figure 49. In addition, the top section of the back hatch was left open to provide better access to the batteries during the test. The MFRI firefighters stated that they would normally attempt to open the back hatch or trunk as one of their first actions if this were a real fire scenario. As such, for safety reasons, as a means to limit the touching, moving, and manipulating of the VFT as the firefighters are standing within a few feet of a potentially fully involved battery, the top portion of the back hatch was kept open from the beginning of the test. Ultimately, having the hatch open also greatly aided in the video recording and still photography captured during the tests.

All tests were conducted with a defacto incident commander and assistant and two active firefighters; one on the nozzle and one on the hose. This is equivalent to one company, as defined by NFPA 1710, *Standard for the Organization and Deployment of Fire Suppression Operations, Emergency Medical Operations, and Special Operations to the Public by Career*

*Fire Departments*, 2010 edition. All staff outside of the suppression team was kept behind a 50-foot perimeter around the VFT. A 1.75-inch diameter hose line fed by a private hydrant was used to supply the Elkhart Brass - Chief nozzle (model no. 4000-10, variable fog 30 degree, 60 degree, and 90 degree), which discharged approximately 125 gallons of water per minute (gpm) at 75 psi. The water usage was tracked by Exponent staff (time of application estimates) during the tests so that an estimate of the total water used for suppression could be determined. Final data was cross checked with video recording for accuracy. In addition, interviews with the firefighters after the tests were conducted to, among other things, gain insight into:

- What they saw;
- How they attacked the fire;
- How the fire differed from a conventional vehicle fire;
- What they may have learned from the test regarding tactics; and
- General observations.

The two firefighter suppression team donned full SCBA and firefighting turnout gear prior to the beginning of the test and only removed their SCBAs if they needed to swap out a cylinder or once the fire was deemed “out.” The turnout gear consisted of:

- Polybenzimidazole (PBI) coat (Globe G-Extreme or Lion Apparel Janesville);
- PBI pants (Morning Pride);
- Polycarbonate helmet (Morning Pride Ben Franklin II or MSA 660);
- Kangaroo skin (Honeywell) or leather (Shelby) gloves;
- PBI (Firecraft) or lanzing (PAC II) hood; and
- Leather boots (Warren Pro or HAIX).